



# MCD237BT

## INSTALLATION/OWNER'S MANUAL

AM/FM/CD Marine Receiver





## Preparation

Please read entire manual before installation.

### Before You Start

- Disconnect negative battery terminal. Consult a qualified technician for instructions.
- Avoid installing the unit where it would be subject to high temperatures, such as from direct sunlight, or where it would be subject to dust, dirt or excessive vibration.

### Getting Started

- Remove trim ring from unit.
- Remove 2 transit screws located on top of the unit.
- Insert the supplied keys into the slots as shown, and slide the unit out of the mounting sleeve.
- Install mounting sleeve into opening, bending tabs to secure.
- Connect wiring harness and antenna. Consult a qualified technician if you are unsure.
- Certain vehicles may require an installation kit and/or wiring harness adapter (sold separately).
- Test for correct operation and slide into mounting sleeve to secure.
- Snap trim ring into place.

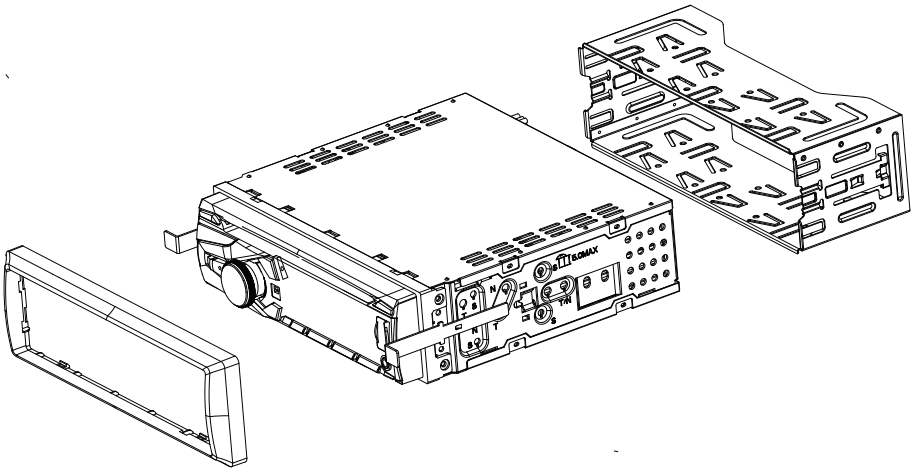

**TYPICAL FRONT-LOAD DIN MOUNTING METHOD**

# Wiring Diagram

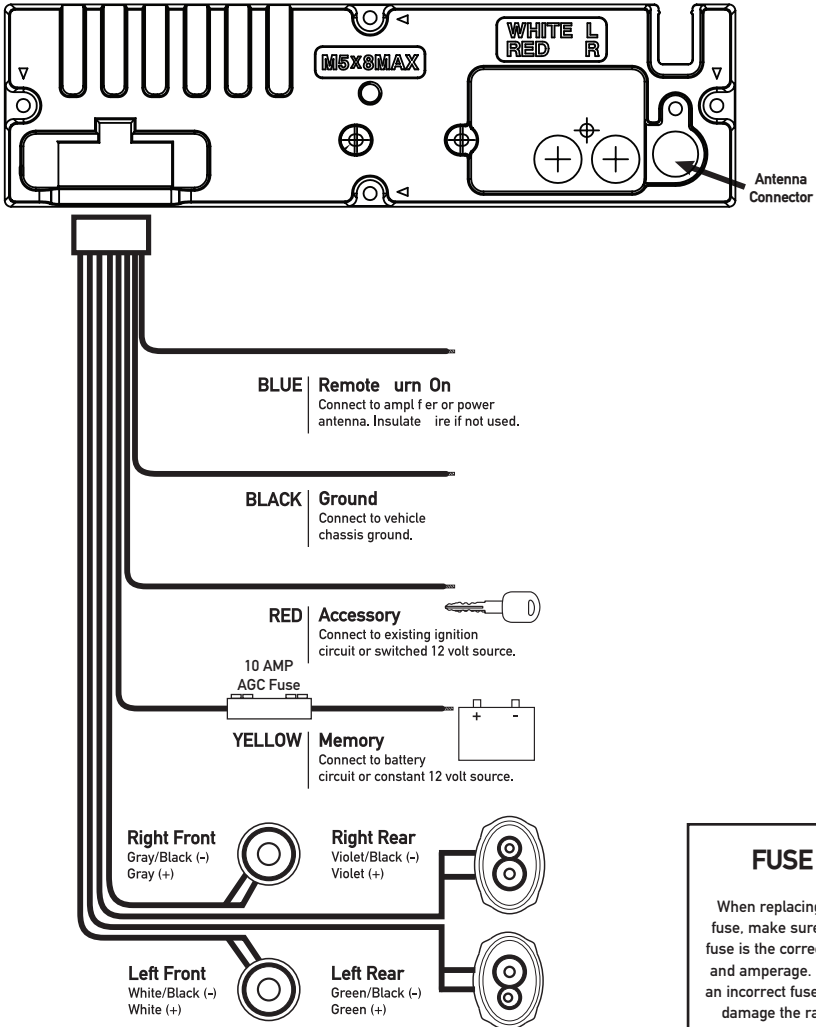

**FUSE**

When replacing the fuse, make sure new fuse is the correct type and amperage. Using an incorrect fuse could damage the radio.

The unit uses one 10 amp AGC fuse located beside the wiring connector.

# Control Locations

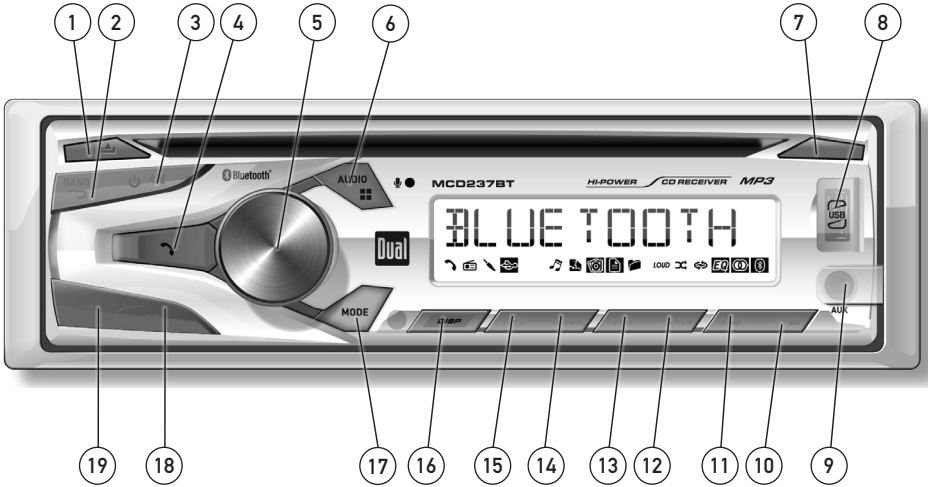

- |                        |                           |
|------------------------|---------------------------|
| ① Release              | ⑪ Preset 5 / Folder Down  |
| ② Band / Go Back       | ⑫ Preset 4 / Play / Pause |
| ③ Power / Mute         | ⑬ Preset 3 / Intro        |
| ④ Bluetooth Talk       | ⑭ Preset 2 / Random       |
| ⑤ Volume Knob          | ⑮ Preset 1 / Repeat       |
| ⑥ Audio / Menu         | ⑯ Display                 |
| ⑦ Eject                | ⑰ Mode                    |
| ⑧ USB Port             | ⑱ Tune / Track Up         |
| ⑨ Auxiliary Input      | ⑲ Tune / Track Down       |
| ⑩ Preset 6 / Folder Up |                           |

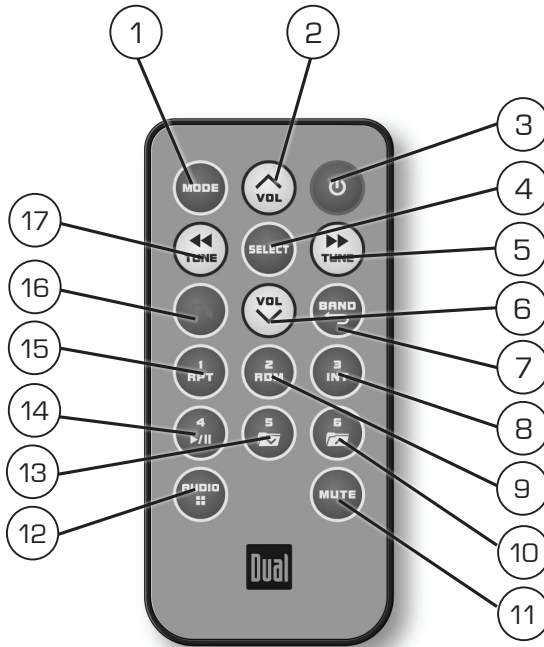

## Remote Control



- |                     |                           |
|---------------------|---------------------------|
| ① Mode              | ⑩ Preset 6 / Folder Up    |
| ② Volume Up         | ⑪ Mute                    |
| ③ Power             | ⑫ Audio / Menu            |
| ④ Select            | ⑬ Preset 5 / Folder Down  |
| ⑤ Tune / Track Up   | ⑭ Preset 4 / Play / Pause |
| ⑥ Volume Down       | ⑮ Preset 1 / Repeat       |
| ⑦ Band / Go Back    | ⑯ Bluetooth Talk          |
| ⑧ Preset 3 / Intro  | ⑰ Tune / Track Down       |
| ⑨ Preset 2 / Random |                           |



## General Operation

<b>Power On/Off</b>	Press  or any other button (except <b>EJECT</b> ) to turn the unit on. Press  to turn the unit off.
<b>Mode</b>	Press <b>MODE</b> to select between AM/FM, CD player, Bluetooth, auxiliary and USB. Modes of operation are shown in the display.  <b>NOTE:</b> CD and USB modes will not appear unless a CD is inserted or USB device is connected.
<b>Auxiliary Input</b>	The MCD237BT offers a 3.5 mm auxiliary input port on the front panel of the unit for connecting an audio device, MP3 player, etc. Press <b>MODE</b> to select auxiliary input mode.
<b>Volume</b>	Adjust volume using volume knob (00-46).
<b>Display</b>	Press <b>DISP</b> to show the clock. During playback of MP3/files, ID3 tag information, elapsed time, track number and file/ folder names will automatically rotate on the display.
<b>Reset</b>	Press <b>RESET</b> upon initial installation or if abnormal operation occurs.
<b>Set the Clock</b>	With the unit on, press and hold <b>DISP</b> until the clock begins to flash, then release. Turn the <b>volume knob</b> to the right to adjust the hours or to the left to adjust the minutes.
<b>12/24-hour Clock</b>	The clock will display 12-hour AM/PM time in USA frequency spacing mode (PM 10:00). In European frequency spacing mode, the clock will display 24-hour time (22:00).
<b>Setup Menu</b>	Press and hold <b>AUDIO</b> for more than 3 seconds to access the setup menu. Press <b>AUDIO</b> momentarily to select between the menu functions and rotate the <b>volume knob</b> left/right to adjust or activate the desired function.

## General Operation - Setup Menu

Menu Function	Options	Action
Auto Station Store	AUTO STORE	Press the <b>volume knob</b> to seek and save 6 strong stations in the current band. <b>(Tuner mode only)</b>
Local/Distance Tuning	LOCAL OFF	Activates distance tuning <b>(Tuner mode only)</b> .
	LOCAL ON	Activates local tuning for strong station reception only <b>(Tuner mode only)</b> .
Tuner Frequency Spacing	FREQ USA	Programs the unit to USA tuner spacing. (200kHz for FM and 10kHz for AM). <b>(Tuner mode only)</b>
	FREQ EURO	Programs the unit to European tuner spacing. (50kHz for FM and 9kHz for AM). <b>(Tuner mode only)</b>
Auxiliary Input	AUX ON	Enables the front panel 3.5mm auxiliary input.
	AUX OFF	Disables the front panel 3.5mm auxiliary input.
Beep Confirmation	BEEP OFF	Disables the confirmation beep.
	BEEP ON	Enables the confirmation beep.
Programmable Turn On Volume	PRO-VOL #	Programs unit to always turn on at a specific volume (default is OFF). Any volume level 1-30 can be selected.
Power On Message	MSG OFF	Disables power on message. (Example: GOOD MORNING)
	MSG ON	Enables power on message to be displayed.
Scrolling Option	SCROLL 15 SP	Programs unit to scroll information every 15 seconds (default).
	SCROLL ONCE	Programs unit to scroll once then show the first 10 characters on display
	SCROLL ON	Programs unit to scroll continuously.
	SCROLL OFF	Programs the unit to show the first 10 characters on display.
Demonstration Mode	DEMO OFF	Disables the demonstration mode.
	DEMO ON	Enables the demonstration mode.
Bluetooth	BT ON	Enables Bluetooth functionality.
	BT OFF	Disables Bluetooth functionality.
Auto Answer	ANSWER Auto	Programs unit to automatically answer every incoming phone call after 2-3 rings.
	ANSWER Manual	Programs unit to require the  button must be pressed to answer incoming phone calls (default).



## General Operation

- Audio** Press **AUDIO** momentarily to select between Bass, Treble, Balance and Fader.
- BASS → TREBLE → BALANCE → FADER → EQ → LOUD → SOURCE LEVEL →
- Bass** Press **AUDIO** until **BASS** appears then rotate volume knob left/right to adjust ( -6 minimum / +6 maximum).
- Treble** Press **AUDIO** until **TREBLE** appears then rotate volume knob left/right to adjust ( -6 minimum / +6 maximum).
- Balance** Press **AUDIO** until **BAL** appears then rotate volume knob left/right to adjust (BAL 12L - BAL 12R).  
BAL EVEN represents equal balance
- Fader** Press **AUDIO** until **FAD** appears then rotate volume knob left/right to adjust (FAD 12R - FAD 12F).  
FAD EVEN represents equal fader





## AM/FM Tuner Operation

<b>Seek Tuning</b>	Press <b>TUNE</b> ◀◀ or <b>TUNE</b> ▶▶ momentarily to seek to the next strong station.
<b>Manual Tuning</b>	<p>Press and hold <b>TUNE</b> ◀◀ or <b>TUNE</b> ▶▶ until "MANUAL" appears, then press <b>TUNE</b> ◀◀ or <b>TUNE</b> ▶▶ momentarily to change radio frequency up or down one step at a time. Press and hold to advance quickly.</p> <p><b>Note:</b> Seek and manual tuning functions are reversed if Seek Priority is set to SEEK 2 in the setup menu (refer to page 7 for details on setting Seek Priority).</p>
<b>Band</b>	Press <b>BAND</b> to select between FM1, FM2, FM3, AM1 and AM2 bands.
<b>Storing and Recalling Station Presets</b>	Up to 18 FM stations and 12 AM stations can be stored. To store a station, select the desired band and station. Press and hold the desired preset button (1-6) for more than 2 seconds. When stored, the preset number will appear in the display. The station can be recalled anytime by pressing the corresponding preset button.
<b>Automatically Store Stations</b>	Press and hold <b>AUDIO/MENU</b> for more than 3 seconds to find auto store in the display. Then press volume knob to automatically store strong 6 stations in the current band.



## CD Player Operation

<b>Insert CD</b>	With the label facing up, insert a standard size CD into the CD slot. The CD will automatically begin playback.
<b>Eject CD</b>	Press <b>EJECT</b> to eject the CD. The unit will change to previous mode of operation. If the disc is not removed within 10 seconds, the unit will reload the disc. The unit does not have to be turned on to eject CD.
<b>Track Select</b>	Press <b>TRACK ►►</b> to skip to the beginning of the next track. Press <b>TRACK ◄◄</b> to return to the beginning of the current track. Pressing <b>TRACK ◄◄</b> again skips to the beginning of the previous track.
<b>Fast Forward/Reverse</b>	Press and hold <b>TRACK ►►</b> or <b>TRACK ◄◄</b> on the remote control to fast forward or reverse a track.
<b>Pause</b>	Press <b>►/  </b> to temporarily stop CD playback. Press <b>►/  </b> again to resume playback.
<b>Intro</b>	Press <b>INT</b> to enter the Intro menu, then turn the volume knob to select one of the following options: <ul style="list-style-type: none"><li>• OFF - Cancels the INT function.</li><li>• ALL - Plays the first 10 seconds of each track.</li></ul>
<b>Repeat</b>	Press <b>RPT</b> to enter the Repeat menu, then turn the volume knob to select one of the following options: <ul style="list-style-type: none"><li>• ALL - Plays all tracks on CD.</li><li>• TRACK - Continuously repeats selected track.</li></ul>
<b>Random</b>	Press <b>RDM</b> to enter the Random menu, then turn the volume knob to select one of the following options: <ul style="list-style-type: none"><li>• OFF - Cancels the RDM function.</li><li>• ALL - Plays all tracks in random order.</li></ul>
<b>CD-R/CD-RW Compatibility</b>	<p>Some CD-Rs and CD-RWs may be incompatible with this unit, depending on media type and recording method. In addition, the following CDs may be incompatible with this unit:</p> <p>CDs exposed to extreme temperatures or direct sunlight for extended periods of time. CDs recorded in which a recording session failed or a re-recording was attempted and, or encrypted or copy-protected CDs which do not conform to the audio CD-DA red book recording standard.</p>

## CD Player Operation - MP3 Files

### Playing an MP3 CD

When an MP3 encoded disc is first inserted, "DISC READ" will appear in the display. Depending on the number of files and folders, this may take several seconds.

### Displaying Information

Press **DISP** to select between song title, artist, file name, folder name, track number, and clock/elapsed time.

"NO ARTIST" or "NO TITLE" will be displayed if the MP3 file contains no ID3 tag information.

"ROOT" will be displayed if the directory name of a root folder is not labeled.

### Title Icon

This icon will illuminate when the song title is displayed.

### Artist Icon

This icon will illuminate when the artist name is displayed.

### Folder Icon

This icon will illuminate when the folder name is displayed.

### File Icon

This icon will illuminate when the file name is displayed.

### Character Support

Maximum character display information

- Track name – 32 character maximum
- Directory name – 32 character maximum
- \*Song title – 32 character maximum
- \*Artist name – 32 character maximum

\*Song title and Artist Name will only be displayed if included with the MP3 file.

When referring to MP3 playback, the following terms are synonymous:

- File name and track name
- Folder name and directory name



## CD Player Operation - MP3 Files

### Media Compatibility

The following types of discs/files are compatible:

- CD-ROM (ISO), CD-R, CD-RW
- CD-DA
- MP3 data

The following types of discs/files are not compatible:

- Discs recorded with Track At Once or packet writing
- MP3 PRO format
- MP3 playlists
- WAV format

### Playback Order

MP3 playback sequence is based on recorded order of files and begins in the root folder of the disc. Any empty folders or folders that do not include MP3 files are skipped. This unit may not play files in the order they were recorded in. Refer to your recording software's user's manual for more information.

### Compatible Recording Formats

- ISO9660 level 1
- ISO9660 level 2
- Yellow Book MODE 1
- Yellow Book MODE 2 FORM 1
- Multi session
- Maximum files - 999
- Maximum folders - 255
- Maximum folder levels - 8
- MPEG-1/2/2.5 Audio Layer-3

ISO9660 standards:

- Maximum nested folder depth is 8 (including the root folder).
- Valid characters for folder/file names are letters A-Z (all caps), numbers 0-9, and “\_” (underscore). Some characters may not be displayed correctly, depending on the character type.
- This device can play back discs in Joliet, Romeo, and other standards that conform to ISO9660. MP3 written in the formats other than the above may not play and/or their file names or folder names may not be displayed properly.



## CD Player Operation - MP3 Files

### Additional MP3 Information

An internal buffer provides ESP (Electronic Skip Protection) to virtually eliminate skipping.

When playing a disc recorded with regular audio files (CD-DA or .WAV) and MP3 files, the unit will play the MP3 files only.

Only MP3 files with filename extension (.mp3) can be played.

Do not attempt to play discs which contain non-MP3 files with the MP3 extension.

### Sampling Frequency Rates MP3

8kHz ~ 48kHz

### Transfer Bit rates MP3

32kbps ~ 320kbps constant  
Variable bit rates

**Note:** Some files may not play or be displayed correctly, depending on sampling rates and bit rates.

### MP3 Tag Display

ID3 tags Version 1.0 to 2.4.  
This model will not display ID3 Version 2.4 or greater tags.

### Recommended Settings

For best results, use the following settings when burning an MP3 disc:  
128kbps or higher constant bit rate  
44.1kHz or higher sampling frequency



## USB Operation

### Connecting a USB Device (sold separately)

To play MP3 files from most USB mass storage devices, line up the USB connector and insert the USB device into the unit's USB port.

### Playing Music

When a USB device is first connected, "USB READ" will appear in the display and playback will begin momentarily. Depending on the number of files and folders, it may take several seconds for the device to begin playing. If no valid MP3 files are detected, "NO FILE" will be displayed and the last mode will be resumed.

### Track Select

Press **TRACK** ►► to skip to the beginning of the next track. Press **TRACK** ◀◀ to return to the beginning of the current track. Pressing **TRACK** ◀◀ again skips to the beginning of the previous track.

### Fast Forward and Reverse

Press and hold **TRACK** ►► or **TRACK** ◀◀ on the remote control to fast forward or reverse a track.

### Pause

Press ►/|| to temporarily stop USB playback.  
Press ►/|| again to resume playback.

### File Search Step 1

Press **SELECT** to enter the file/folder search mode. A list of all the folders from the USB device will be displayed.

**Note:** Any files located in the root directory will be located in the folder named "ROOT". Press **SELECT** to view the files on the root folder.

### Step 2

Turn the volume knob to cycle through all the folders on the device and press **SELECT** to choose the desired folder. The list of files in the selected folder will be displayed. Turn the volume knob to cycle through the list of files.

**Note:** Pressing **GO BACK** when viewing the contents of a folder will return to the list of folders on the USB device. Press **GO BACK** again to exit the search menu.

### Step 3

Once the desired song is displayed, press **SELECT** to begin playback of the desired song.

**Note:** Due to differences in USB device transfer speeds, it is recommended to limit each folder to less than 30 songs.

## USB Operation

### Displaying Information

When a file is accessed, the clock and elapsed time will be displayed. Press **DISP** momentarily to select between song title, artist, file name, folder name, track number and clock/elapsed time.

"NO TITLE" will be displayed if no song title information is available.

"NO ARTIST" will be displayed if no artist information is available.

### Song Title Icon

This icon will illuminate when the song title is displayed.

### Artist Icon

This icon will illuminate when the artist name is displayed.

### Folder Icon

This icon will illuminate when the folder name is displayed.

### File Icon

This icon will illuminate when the file name is displayed.

### Folder Access

Press  to select the previous folder.

Press  to select the next folder.

**Note:** Folder access is only available on devices with more than one folder.

### Repeat

Press **RPT** to enter the Repeat menu, then turn the volume knob to select one of the following options:

- ALL - Plays all tracks on the device.
- TRACK - Continuously repeats selected track.
- FOLDER - Continuously repeats all files in selected folder.

### Random

Press **RDM** to enter the Random menu, then turn the volume knob to select one of the following options:

- OFF - Cancels the RDM function.
- ALL - Plays all tracks in random order.
- FOLDER - Plays all tracks in folder in random order.

**Note:** Random mode is retained in memory when selecting between other modes and when the unit is turned on/off.

### Intro

Press **INT** to enter the Intro menu, then turn the volume knob to select one of the following options:

- OFF - Cancels the INT function.
- ALL - Plays first 10 seconds of each track.
- FOLDER - Plays first 10 seconds of each track in folder.



## USB Operation

### Character Support

- Maximum character display information
- Track name – 32 character maximum
  - Directory name – 32 character maximum
  - \*Song title – 32 character maximum
  - \*Artist name – 32 character maximum

\*Song title and artist name will only be displayed if included with the MP3 file.

### Media Compatibility

The following types of files are compatible:

- MP3 data

The following types of files are not compatible:

- MP3 PRO format
- MP3 playlists
- WAV format

### Playback Order

MP3 playback sequence is based on order the files are copied to the USB device and begins in the root folder. Any empty folders or folders that do not include MP3 files are skipped. Depending on your software, the playback order may vary.

### Playback Capacity

- Maximum number of files: 999
- Maximum number of folders: 255 plus the root directory
- Maximum number of files in each folder and root: 999

**Note:** If the number of files/folders exceeds the maximum outlined above, the additional files/folders will be ignored.

**Note:** Devices that exceed the maximum number of files or folders may not function properly.

### USB Device Compatibility

Due to the differences of USB devices, some devices may not be compatible. USB devices must be 'mass storage class' and formatted to the FAT or FAT32 file system in order to ensure compatibility.





## USB Operation

### Additional MP3 Information

Only MP3 files with filename extension (.mp3) can be played. Do not attempt to play non-MP3 files with the MP3 extension.

### Sampling Frequency Rates MP3

8kHz ~ 48kHz

### Transfer Bit rates MP3

32kbps ~ 320kbps constant  
Variable bit rates

**Note:** Some files may not play or be displayed correctly, depending on sampling rates and bit rates.

### MP3 Tag Display

ID3 tags Version 1.0 to 2.4

**Note:** If an invalid ID3 tag version is detected, "NO SUPPORT" will scroll on the display.



## Bluetooth® Operation

### Pairing a New Device

Before you can use a Bluetooth device, it must be paired and connected. Make sure that Bluetooth is activated on your device before you begin the pairing process.

The unit broadcasts the pairing signal constantly when no devices are currently connected. Complete the pairing sequence from your Bluetooth device. Refer to the owner's manual for your device for more details.

**The device name is "DUAL BT"  
The Bluetooth passcode "1234"**

**Note:** The unit can be in any mode of operation when pairing is performed.

### Pairing Additional Devices



If a device is currently connected, press and hold  to disconnect the current device before a new device can be paired. Then begin the pairing sequence from the new Bluetooth device.

### Connecting a Paired Device

Most Bluetooth devices support the auto-connect feature, and will connect automatically if the device is in range when the unit is powered-on. If your device was previously paired but does not connect, use these instructions below.

- If your most recently connected Bluetooth device becomes disconnected or does not reconnect, press and hold  from Bluetooth mode to reconnect your mobile device.

- To connect a previously paired device that was not recently connected:









- 1) Press and hold  to disconnect any connected mobile devices when Bluetooth is paired. Press and hold  to connect Bluetooth device again when Bluetooth is not paired.
- 2) The paired device name will appear on the LCD once it is connected.
- 3) Turn the **volume knob** to cycle through the list of devices.
- 4) Press the volume knob to cycle through the list of recent calls up to ten and select the phone number to dial when Bluetooth is paired. NONE appears on the LCD if there are no recent calls.

### Disconnecting a Device

Press and hold  for 3 seconds to disconnect a connected device. The device will remain paired and appear in the SEARCH menu, but not be connected.

**Note:** Placing a phone call from your cell phone will also initiate Bluetooth function.

## Bluetooth® Operation

<b>Recent Calls List</b>	Press <b>SELECT</b> from Bluetooth mode to view recent calls dialed, received or missed while connected to the head unit. Turn the volume knob to cycle through the recent phone numbers. Press <b>SELECT</b> or  to dial
<b>Redialing the last number</b>	To redial the last phone number, press  from Bluetooth mode. Press  or <b>SELECT</b> again to redial the phone number.
<b>Receiving a phone call</b>	<p>Incoming phone calls will automatically appear on the display and a ring tone will be heard.</p> <p><b>Note:</b> The volume of the ring tone depends on the volume level of the unit. The incoming ring tone may not be heard if the volume is set to a low level or mute is activated.</p> <ul style="list-style-type: none"><li>• Press  to receive the incoming phone call.</li><li>• Press and hold  to refuse the incoming phone call.</li></ul> <p><b>Note:</b> If <b>Auto Answer</b> is set to <b>ON</b> in the setup menu, all phone calls will be received automatically.</p>
<b>Ending a Phone Call</b>	During an active phone call, press  to end a phone call. If the phone call was received when listening to music in another mode, the unit will resume the previous mode.
<b>Streaming Audio</b>	<p>The unit supports A2DP (advanced audio distribution profile) wireless streaming audio from your Bluetooth mobile device directly to your head unit. The following functions can be used to control the music:</p> <ul style="list-style-type: none"><li>• Press  to skip to the next available audio track.</li><li>• Press  to skip to the previous audio track.</li><li>• Press  to toggle between play and pause during playback.</li></ul>



## Bluetooth® Operation

### Streaming Audio Operation

The unit supports A2DP (advanced audio distribution profile) wireless streaming audio from your Bluetooth mobile device directly to your head unit. You can also control your music from the front panel of the head unit using AVRCP (audio video remote control profile).

**Notes:**

- To stream music to your head unit, your mobile device must support the A2DP and AVRCP Bluetooth profiles. Check the owner's manual of your mobile device for details.
- Streaming audio must be enabled from your mobile device. This option will vary depending on the device. Some devices allow streaming audio to be disabled.

After pairing, connecting and enabling streaming audio from a compatible mobile device, begin playing music using the music player on your mobile device. Once the music is playing, the following functions can be used to control the music:

- The ►► button will skip to the next available audio track.
- The ◀◀ button will skip to the previous audio track.
- The ►/|| button will toggle between play and pause during playback.

**Note:** Some Bluetooth devices may not fully support these commands.

## Troubleshooting

Problem	Cause	Action
Unit will not turn on (no power)	Yellow wire not connected or incorrect voltage Red wire not connected or incorrect voltage	Check connections for proper voltage (11~16VDC)
	Black wire not connected	Check connection to ground
	Fuse blown	Replace fuse
Unit has power (but no sound)	Speaker wires not connected	Check connections at speakers
	One or more speaker wires touching each other or touching chassis ground	Insulate all bare speaker wires from each other and chassis ground
Unit blows fuses	Yellow or red wire touching chassis ground	Check for pinched wire
	Speaker wires touching chassis ground	Check for pinched wire
	Incorrect fuse rating	Use fuse with correct rating
Excessive skipping	Unit is not mounted correctly or backstrap is not secure	Check mounting sleeve and backstrap support
	Physical defect in media (CD, CD-R or CD-RW)	Check media for scratches
ERR FILE appears on display	Disc read error	Press eject or <b>RESET</b>
	Focus error or disc is in upside down	Press eject or <b>RESET</b>
NO FILE appears on display	No playable MP3files found on the device	Check the device for valid MP3 files
Unit will not accept a disc	CD mechanism position out of alignment	Press <b>EJECT</b> to reset CD mechanism position
	CD transit screws still in place	Remove 2 transit screws located on top of the unit
NO SUPPORT appears on display	An invalid ID3 tag version is present	Version 1.0 to 2.0 ID3 tags are supported.



## Limited One Year Warranty

This warranty gives you specific legal rights. You may also have other rights which vary from state to state.

Dual Electronics Corp. warrants this product to the original purchaser to be free from defects in material and workmanship for a period of one year from the date of the original purchase.

Dual Electronics Corp. agrees, at our option, during the warranty period, to repair any defect in material or workmanship or to furnish an equal new, renewed or comparable product (whichever is deemed necessary) in exchange without charges, subject to verification of the defect or malfunction and proof of the date of purchase. Subsequent replacement products are warranted for the balance of the original warranty period.

**Who is covered?** This warranty is extended to the original retail purchaser for products purchased from an authorized Dual dealer and used in the U.S.A.

**What is covered?** This warranty covers all defects in material and workmanship in this product. The following are not covered: software, installation/removal costs, damage resulting from accident, misuse, abuse, neglect, product modification, improper installation, incorrect line voltage, unauthorized repair or failure to follow instructions supplied with the product, or damage occurring during return shipment of the product. Specific license conditions and copyright notices for the software can be found via [www.dualav.com](http://www.dualav.com).

### What to do?

1. Before you call for service, check the troubleshooting guide in your owner's manual. A slight adjustment of any custom controls may save you a service call.
2. If you require service during the warranty period, you must carefully pack the product (preferably in the original package) and ship it by prepaid transportation with a copy of the original receipt from the retailer to an authorized service center.
3. Please describe your problem in writing and include your name, a return UPS shipping address (P.O. Box not acceptable), and a daytime phone number with your shipment.
4. For more information and for the location of the nearest authorized service center please contact us by one of the following methods:
  - Call us toll-free at 1-866-382-5476
  - E-mail us at [cs@dualav.com](mailto:cs@dualav.com)

**Exclusion of Certain Damages:** This warranty is exclusive and in lieu of any and all other warranties, expressed or implied, including without limitation the implied warranties of merchantability and fitness for a particular purpose and any obligation, liability, right, claim or remedy in contract or tort, whether or not arising from the company's negligence, actual or imputed. No person or representative is authorized to assume for the company any other liability in connection with the sale of this product. In no event shall the company be liable for indirect, incidental or consequential damages.



---

## FCC Compliance

This device complies with Part 15 of the FCC Rules. Operation is subject to the following two conditions:

- (1) this device may not cause harmful interference, and
- (2) this device must accept any interference received, including interference that may cause undesired operation.

**Warning:** Changes or modifications to this unit not expressly approved by the party responsible for compliance could void the user's authority to operate the equipment.

**Note:** This equipment has been tested and found to comply with the limits for a Class B digital device, pursuant to Part 15 of the FCC Rules. These limits are designed to provide reasonable protection against harmful interference in a residential installation. This equipment generates, uses and can radiate radio frequency energy and, if not installed and used in accordance with the instructions, may cause harmful interference to radio communications. However, there is no guarantee that interference will not occur in a particular installation. If this equipment does cause harmful interference to radio or television reception, which can be determined by turning the equipment off and on, the user is encouraged to try to correct the interference by one or more of the following measures:

- Reorient or relocate the receiving antenna.
- Increase the separation between the equipment and receiver.
- Connect the equipment into an outlet on a circuit different from that to which the receiver is connected.
- Consult the dealer or an experienced radio/TV technician for help.



## Specifications

<b>CD Player</b>	Frequency response: <b>20Hz-20kHz</b> Channel separation @ 1kHz: <b>&gt;60dB</b> D/A converter: <b>1 Bit</b>
<b>FM Tuner</b>	Tuning range: <b>87.5MHz-107.9MHz</b> Usable sensitivity: <b>8.5dBf</b> 50dB quieting sensitivity: <b>10dBf</b> Stereo separation @ 1kHz: <b>&gt;30dB</b> Frequency response: <b>30Hz-13kHz</b>
<b>AM Tuner</b>	Tuning range: <b>530kHz-1710kHz</b> Usable sensitivity: <b>&lt;42dBu</b> Frequency response: <b>30Hz-2.2kHz</b>
<b>General</b>	USB Charge: <b>1A</b> Speaker output impedance: <b>4~8 ohms</b> Line output voltage: <b>1.2 Volts RMS</b> Dimensions: <b>7" x 7" x 2" (178 x 178 x 50 mm)</b>

Design and specifications subject to change without notice.



### CEA-2006 Power Standard Specifications (reference: 14.4VDC +/- 0.2V, 20Hz~20kHz)

Power Output: 16 Watts RMS x 4 channels at 4 ohms and  $\leq 1\%$  THD+N  
Signal to Noise Ratio: 80dBA (reference: 1 watt into 4 ohms)





---

# Notes



**Dual Electronics Corp.**  
**Toll Free: 1-866-382-5476**  
**9AM-5PM EST, Monday-Friday**

[www.dualav.com](http://www.dualav.com)

©2016 Dual Electronics Corp. All rights reserved.

The Bluetooth® word mark and logos are owned by the Bluetooth SIG, Inc.  
and any use of such marks by Namsung is under license.

Other trademarks and trade names are those of their respective owners.

NSA1116-V01