

DLS404

DLS464

DLS524

DLS574

DLS654

DLS694



DLS SERIES

INSTALLATION/OWNER'S MANUAL

Car Audio Speakers





Installation

Thank you for purchasing the DLS Series car speakers. Although Dual has attempted to make sure all of the information contained within this manual is accurate, please be aware that any part of it is subject to change without notice.



CAUTION

The following instructions should be used as a general guideline only. If you are unsure about performing any of the procedures listed below, please consult a professional car audio installation center.

Before installation, please follow these guidelines:

1. Be sure to carefully read and understand the instructions before attempting to install this product.
2. For safety, disconnect the negative terminal from the battery prior to beginning the installation.
3. Use the highest quality connectors for a reliable installation and to minimize signal or power loss.
4. Use caution before you drill or cut! Be careful not to cut or drill into gas tanks, fuel lines, brake or hydraulic lines, vacuum lines or electrical wiring when working on any vehicle.
5. Never run speaker wires underneath your vehicle. Running speaker wires inside the vehicle provides the best protection from exhaust heat and environmental elements.
6. Avoid running wires over, near, or through sharp edged surfaces. Use rubber grommets to protect any wires routed through metal.
7. When running the speaker cable from the amplifier, avoid running it near sources of high current (i.e. wiring harnesses, battery cables).

Mounting

1. Determine where the speakers will be mounted. Make sure the area is large enough for the speaker to mount evenly. Also ensure the mounting location is deep enough for the speaker to fit.
2. Refer to the specification chart to determine the proper diameter hole to cut for your speaker model.
3. If needed, use the grille as a template to mark the locations for the mounting screws. Drill the holes with a 3/32" bit.
4. Be sure to observe proper polarity when connecting the wires. The speaker's positive terminal is indicated with a "+" symbol.
5. Fit the speaker to the hole cut-out and mount using the supplied screws. If using the speaker grille, insert 4 screws into the grille holes and mount the speaker.

DLS404

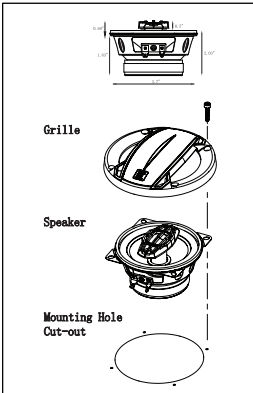

DLS464

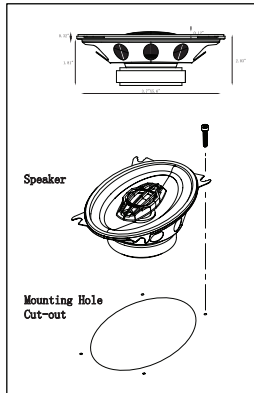

DLS654

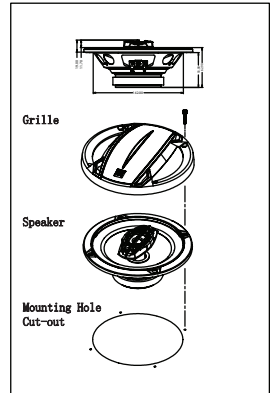

DLS694

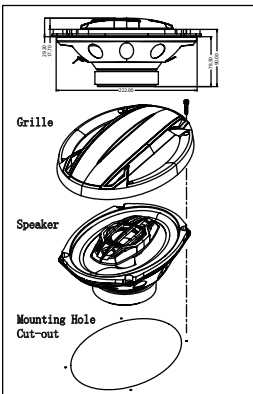

DLS524

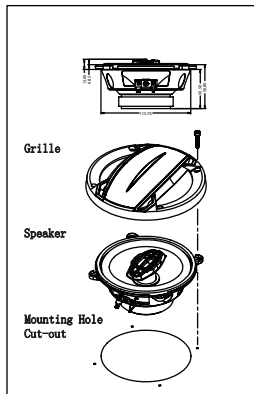

DLS574

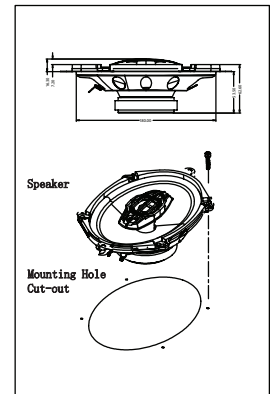



Specifications

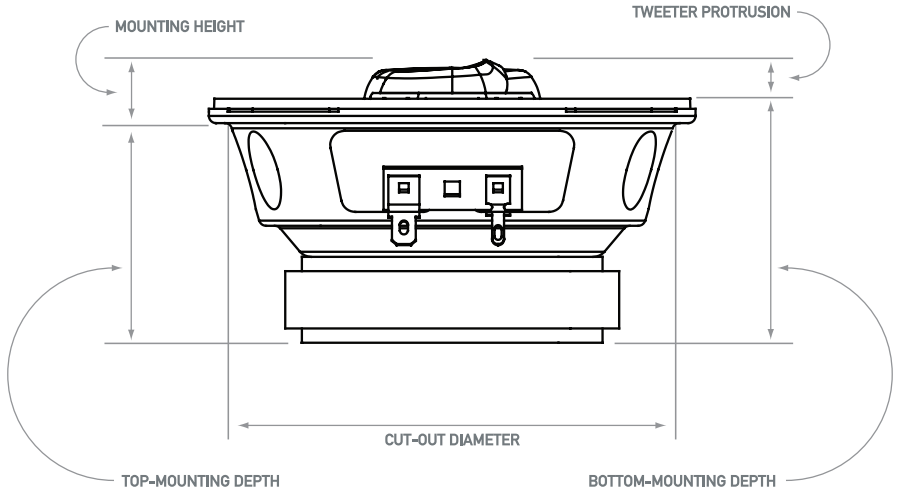

The above diagram is to be used with the specifications matrix guide below. Design and specifications subject to change without notice.

	Mounting Height	Top-Mounting Depth	Tweeter Protrusion	Bottom-Mounting Depth	Cut-out Diameter	Sensitivity (dB)	Frequency Response	RMS Power (Watts)	Peak Power (Watts)
DLS404	.69"	1.83"	.50"	2.03"	3.70"	85	123Hz-20kHz	20	80
DLS464	.32"	1.81"	.12"	2.03"	3.7" x 5.6"	85	105Hz-20kHz	20	80
DLS524	.39"	1.97"	.12"	2.20"	4.50"	85	75Hz-20kHz	30	120
DLS574	.67"	2.28"	.28"	2.60"	5" x 7.10"	87	70Hz-20kHz	40	160
DLS654	.79"	2.17"	.59"	2.36"	5.60"	87	70Hz-20kHz	40	160
DLS694	.87"	3.07"	.39"	3.54"	6" x 8.58"	89	50Hz-20kHz	50	200



Limited One Year Warranty

This warranty gives you specific legal rights. You may also have other rights which vary from state to state.

Dual Electronics Corp. warrants this product to the original purchaser to be free from defects in material and workmanship for a period of one year from the date of the original purchase.

Dual Electronics Corp. agrees, at our option, during the warranty period, to repair any defect in material or workmanship or to furnish an equal new, renewed or comparable product (whichever is deemed necessary) in exchange without charges, subject to verification of the defect or malfunction and proof of the date of purchase. Subsequent replacement products are warranted for the balance of the original warranty period.

Who is covered? This warranty is extended to the original retail purchaser for products purchased and used in the U.S.A.

What is covered? This warranty covers all defects in material and workmanship in this product. The following are not covered: installation/removal costs, damage resulting from accident, misuse, abuse, neglect, product modification, improper installation, incorrect line voltage, unauthorized repair or failure to follow instructions supplied with the product, or damage occurring during return shipment of the product.

What to do?

1. Before you call for service, check the troubleshooting guide in your owner's manual. A slight adjustment of any custom controls may save you a service call.
2. If you require service during the warranty period, you must carefully pack the product (preferably in the original package) and ship it by prepaid transportation with a copy of the original receipt from the retailer to an authorized service center.
3. Please describe your problem in writing and include your name, a return UPS shipping address (P.O. Box not acceptable), and a daytime phone number with your shipment.
4. For more information and for the location of the nearest authorized service center please contact us by one of the following methods:

- Call us toll-free at 1-866-382-5476
- E-mail us at cs@dualav.com

Exclusion of Certain Damages: This warranty is exclusive and in lieu of any and all other warranties, expressed or implied, including without limitation the implied warranties of merchantability and fitness for a particular purpose and any obligation, liability, right, claim or remedy in contract or tort, whether or not arising from the company's negligence, actual or imputed. No person or representative is authorized to assume for the company any other liability in connection with the sale of this product. In no event shall the company be liable for indirect, incidental or consequential damages.



Registration

For Your Records

Please keep your original sales receipt and be prepared to provide it in the event you require service. Your original receipt is considered the best proof of purchase and indicates the date you purchased your Dual product.

Dealer Name _____

Dealer Phone _____

Purchase Date _____

Register Your Product

Register your product online at www.dualav.com





Dual Electronics Corporation
Toll Free: 1-866-382-5476
9AM-5PM EST, Monday - Friday

www.dualav.com

©2016 Dual Electronics Corp. All rights reserved.
NSA0716-V1