



DMD7W

INSTALLATION/OWNER'S MANUAL

Dash Mount 7" Touchscreen Monitor with Wireless Apple CarPlay® and Android



Copyright Notes

The Bluetooth® word mark and logos are owned by the Bluetooth SIG, Inc.

Use of the Apple CarPlay logo means that a vehicle user interface meets Apple performance standards. Apple is not responsible for the operation of this vehicle or its compliance with safety and regulatory standards. Please note that use of this product with iPhone, iPod or iPad may affect wireless performance. Apple CarPlay is a trademark of Apple Inc. "Made for iPod" and "Made for iPhone" mean that an electronic accessory has been designed to connect specifically to iPod or iPhone, respectively, and has been certified by the developer to meet Apple performance standards. iPhone and iPod are trademarks of Apple, Inc., registered in the U.S. and other countries.

Availability of Android may vary depending upon your country and phone model. Please visit android.com/auto for more information. Android, Android Auto, Google and other marks are trademarks of Google Inc.

Other trademarks and trade names are those of their respective owners.

Table of Contents	Page
Important Notes	3
FCC Compliance	3
Preparation/Mounting	4
Wiring Diagram	5
Control Locations	6
General Operation	7-8
Audio Operation	9
FM Transmitter Operation	9
USB Operation	10
Media Compatibility	11-12
Bluetooth Operation	13-14
Driving Orientation Settings	15
Wired & Wireless Apple CarPlay Operation	16
Wired & Wireless Android Operation	16
Apple CarPlay Operation	17-18
Android Operation	19-20
Register Your Product	21
Specifications	22
Warranty	23



Important Notes

Please read the instructions carefully before attempting to operate.

- Ensure that the 8A8K + is mounted in a place that will not block your view of the road.
- The 8A8K + has a built-in speaker. However, to play music over your car radio please ensure that the FM Transmitter function has been set up and is connected properly with your car radio (see page 9) or use the 3.5mm audio output located on the 12v power adapter and connect to your car radio AUX input (if available).
- Some Android operating versions may not be compatible with the Android app. As such, we strongly recommend updating your phone's operating system to the latest version.
- Ensure that you are using the power cable provided with the purchase of your phone (or compatible cable) to connect the 8A8K + and your phone for charging or for wired Apple CarPlay or Android playback.
- Apps displayed on the 8A8K + (when pairing with either the Carplay® or Android app) will vary depending on the apps available on the connected phone.
- The 8A8K + does not have an internal GPS. All Navigation apps are functionally dependent on the connected phone.

FCC Compliance

This device complies with Part 15 of the FCC Rules. Operation is subject to the following two conditions:

(1) this device may not cause harmful interference, and

(2) this device must accept any interference received, including interference that may cause undesired operation.

Warning: Changes or modifications to this unit not expressly approved by the party responsible for compliance could void the user's authority to operate the equipment.

This equipment complies with FCC radiation exposure limits set forth for an uncontrolled environment.

This equipment should be installed and operated with a minimum distance of 20cm between the radiator & your body.

This transmitter must not be co-located or operating in conjunction with any other antenna or transmitter.

Note: This equipment has been tested and found to comply with the limits for a Class B digital device, pursuant to Part 15 of the FCC Rules. These limits are designed to provide reasonable protection against harmful interference in a residential installation. This equipment generates, uses and can radiate radio frequency energy and, if not installed and used in accordance with the instructions, may cause harmful interference to radio communications. However, there is no guarantee that interference will not occur in a particular installation. If this equipment does cause harmful interference to radio or television reception, which can be determined by turning the equipment off and on, the user is encouraged to try to correct the interference by one or more of the following measures:

- Reorient or relocate the receiving antenna.
- Increase the separation between the equipment and receiver.
- Connect the equipment into an outlet on a circuit different from that to which the receiver is connected.
- Consult the dealer or an experienced radio/TV technician for help.

Preparation

Before You Start

- Avoid installing the unit where it would be subject to high temperatures from direct sunlight, dust, dirt or excessive vibration.

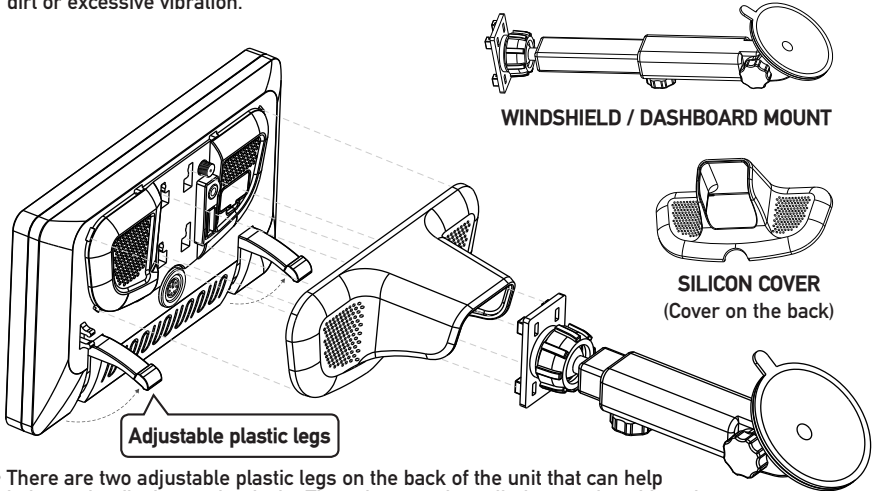

- There are two adjustable plastic legs on the back of the unit that can help balance the display on the dash. These legs can be pulled out and positioned independently, depending on the contour of the dash location. They will help to stabilize the unit and prevent unwanted vibration of the display.

Attached to the windshield

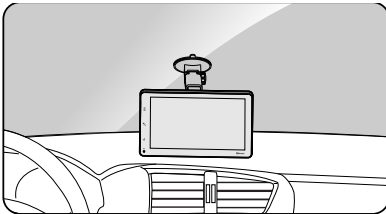

Attached to the dashboard mount

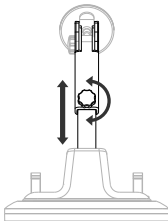
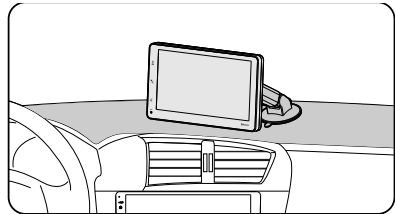

Stretchable

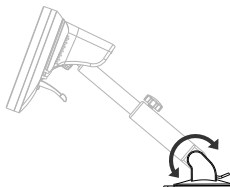

Can rotate 180 degrees

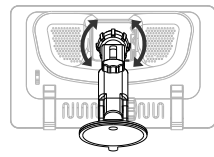

Can rotate 360 degrees



DMD7W INSTALLATION

Wiring Diagram - Inputs/Outputs

GPS ANTENNA

Note: Use to improve map accuracy.

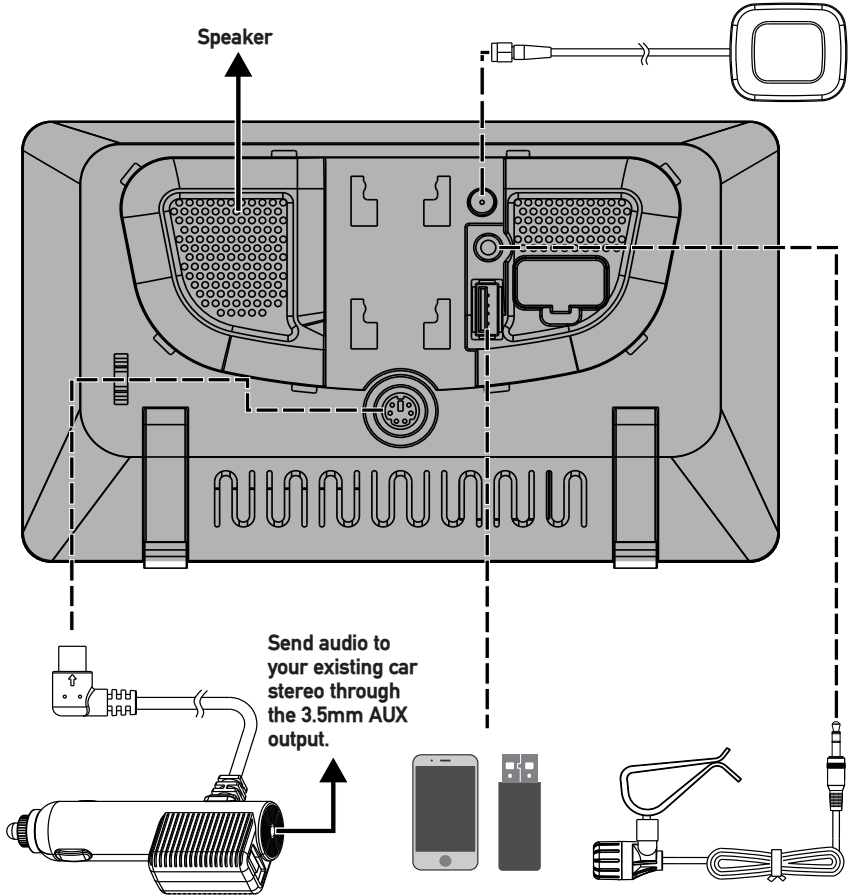

12V Power Adapter
USB port for charging only (2.1A)
3.5mm output to connect audio to your car stereo

USB Playback
Wired Apple CarPlay and Android Connection

External Microphone
Use to improve voice quality.







Control Locations



The radio display features the following functions and displays:

- ① POWER/MUTE
- ② DIMMER
- ③ VOICE ACTIVATION BUTTON
- ④ INTERNAL MICROPHONE

General Operation



- Power On/Off** Long press  to turn the unit on. Press and hold to turn the unit off.
- Volume** Press  at the top left corner of the screen to display the volume. Press  or  to increase or decrease the volume level.
- Mute** Momentarily press  to silence the audio. Momentarily press **MUTE** again to return to the previously selected volume.
- Mode** Press  at the top left corner of the screen to display the main menu.

Apple CarPlay/Android/BT Phone/BT Audio/USB/Settings/FM Transmitter.

Note: Modes of operation can also be accessed by selecting the corresponding icon from the main menu.

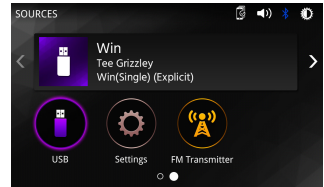
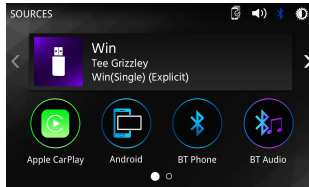
- Main Menu** Operation Mode Selection: Press the  at the top left corner of the screen to display the OSD main menu. Press the Apple CarPlay/Android/BT Phone/BT Audio/USB/Settings/FM Transmitter in the Main menu page to select the desired source.



- Dimmer Mode** Press the  to adjust to change the mode (Auto/Day/Night).
- Dimmer** Press the  to adjust the brightness.
- USB** Insert a USB flash drive to play MP3/FLAC files.

General Operation

Setup Menu

From the Main Menu screen, select Setup to access the Settings menu and select from categories represented by the icons on the bottom of the screen: General, Audio, Display, Others. Select the category, and adjust any of the available options using the touch screen.

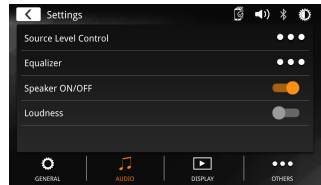
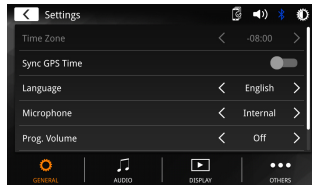

General:

- **Time Zone**-Select the time zone.
- **Sync GPS Time**- Synchronizes the clock time with the GPS.
- **Language** - Select Language.
- **Microphone** - Optional external or internal (Default) microphone.
- **Prog.Volume**- Press > or < to set the volume after device startup
- **Right Hand Drive**- Turn the Right Hand Drive On or Off. When the item is off, it is left hand drive mode, and when the item is On, it is right hand drive mode. And this item default will be off (left hand drive mode).

Audio:

- **Source Level Control**- Touch to set the volume of each source.
- **Equalizer**-Select between the following EQ presets: Default, User, Classic, Rock, Jazz, Electric, Pop, Soft (allows user to enter custom EQ settings).
- **Speaker ON/OFF**- Speaker can be turned On or Off.
- **Loudness** - Touch screen button to turn the Loudness function on/off.

Display:

- **Brightness**- Press > or < to adjust to desired level.
(0 Minimum/20 maximum: Day: 20 is default, Night: 6 is default).
- **Color Brightness**- Press > or < to adjust to desired level.
(0 Minimum/24 maximum).

Others:

- **Factory Default**-Reset Bluetooth Settings or Reboot System.
- **System Version**-Displays software version of unit.
- **Open Source License**

Audio Operation

Equalizer Menu

Press the "Settings" icon on the main menu screen to adjust the Balance and Equalizer controls (16-Band Tone Control and 8 Presets EQ Settings).

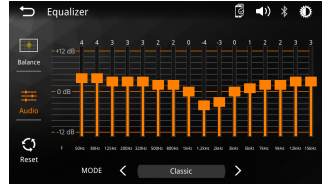

FM Transmitter

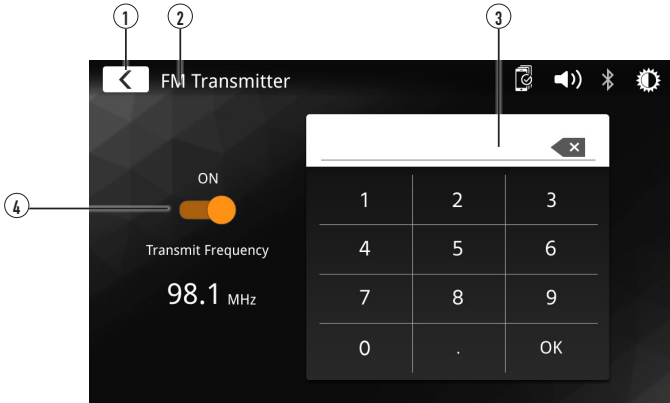

FM Transmitter Operation

From the main menu, touch FM Transmitter icon on the screen to select FM Transmitter mode.

Main Menu ①

Press icon to return to Main Menu screen.

Current Mode Indicator ②

Display status of various tuning functions including Auto.

Keypad ③

Direct search keypad for setting the FM station for audio transmitting.

FM Transmitter On/Off ④

FM transmitter can be turned on or off. (Default : OFF)

USB Operation

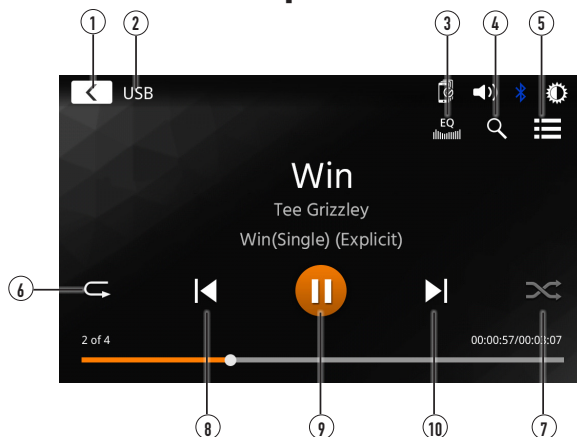

- | | |
|--|--|
| <p>USB</p> <p>Main Menu ①</p> <p>Current Mode Indicator ②</p> <p>EQ ③</p> <p>Search ④</p> <p>List ⑤</p> <p>Repeat ⑥</p> <p>Random ⑦</p> <p>Track Down ⑧</p> <p>Play / Pause ⑨</p> <p>Track Up ⑩</p> | <p>From the main menu, touch the USB icon on the main screen.</p> <p>Press icon to return to Main Menu screen.</p> <p>Displays source currently playing.</p> <p>Press the icon to adjust Equalizer setting.</p> <p>Press icon to search a music file.</p> <p>Press icon to access a list of all files and folders on the device.</p> <ul style="list-style-type: none"> - Press to access the root directory - Press a folder name to access that folder, and press to return to the file list - Use the up and down arrows to navigate the file list - Press the "BACK" arrow to return to the previous screen. <p>Press icon to repeat current track and adjust to repeat all tracks in the current folder. Touch RPT again to exit repeat mode.</p> <p>Press icon to shuffle all tacks in the current folder. and again to shuffle all tracks. Touch icon again to exit Repeat mode.</p> <p>Press icon to return to the beginning of the current track.</p> <p>Press icon to pause or resume playback.</p> <p>Press icon to skip ahead to the next song</p> |
|--|--|



DMD7W INSTALLATION

Media Compatibility

File Type			MP3	
File System	FAT	FAT 12	X	
		FAT 16/FAT 32	✓	
File Extension	.mp3/.MP3/.Mp3/.mP3/.flac		✓	
	.rmp/.m4a		X	
MPEG Format	MPEG 1		✓	
	MPEG 2		✓	
	MPEG 2.5		✓	
Sampling Frequency	MPEG 1		32/44.1/48kHz	
	MPEG 2		12/16/22.05/24kHz	
	MPEG 2.5		8/11.025/12kHz	
Bitrate	MPEG 1		32 ~ 320kbps	
	MPEG 2		8 ~ 160kbps	
	MPEG 2.5		8 ~ 160kbps	
Other Information	Directory Depth		Unlimited	
	File Name Length		32 bytes	
	Total File Number		2000 files	
	Total Folder Number		200 folders	
	File Number via Folder		2000 files	
	MP3 ID3 TAG	ver.1.x		✓
		ver.2.x		✓
Title, Artist, Album		✓		

Notes:

- Due to ongoing technological advancement, some USB flash drives may be incompatible with this unit.



Media Compatibility

Media Compatibility	<p>The following types of files are not compatible:</p> <ul style="list-style-type: none">• MP3 PRO format, MP3 playlists• RMP format• AAC, protected AAC, M4A format
Playback Order	<p>MP3 playback sequence begins in the root folder of the USB device. Any empty folders or folders that do not include MP3 files are skipped.</p>
Compatible Recording Formats	<p>ISO9660 standards:</p> <ul style="list-style-type: none">• Maximum nested folder depth is 8 (including the root folder).• Valid characters for folder/file names are letters A-Z (all caps), numbers 0-9, and "_" (underscore). Some characters may not be displayed correctly, depending on the character type.• This device can play back files in Joliet and other standards that conform to ISO9660. MP3 written in the formats other than the above may not play and/or their file names or folder names may not be displayed properly.
Notes	<p>Some files may not play or be displayed correctly, depending on sampling rates and bit rates.</p> <p>For best results, use the following settings when ripping MP3 files: 128kbps or higher constant bit rate 44.1kHz or higher sampling frequency</p>

Bluetooth Operation

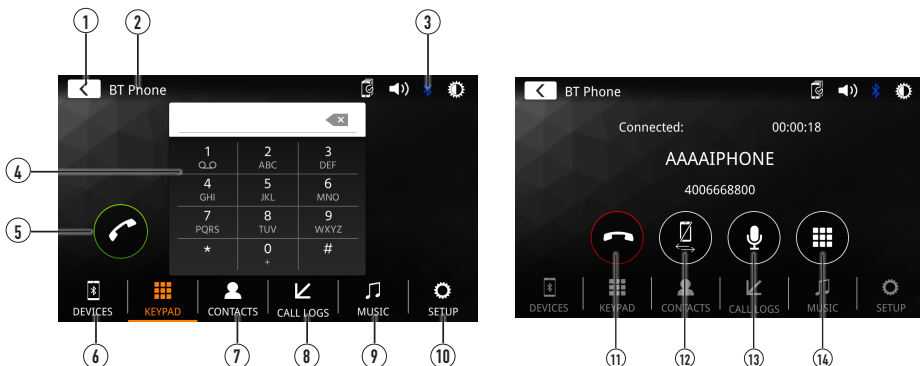

Before using Bluetooth

Before you can use a Bluetooth device to make hands-free calls or stream audio. It must be authenticated. This is also referred to as "pairing" a device.

Pairing a New Device

The unit broadcasts the pairing signal constantly when no devices are currently connected. Complete the pairing sequence from your Bluetooth device. Refer to the owner's manual for your device for more details. **The device name is "DMD7W".** The unit can be in any mode of operation when pairing is performed. On certain phones, pairing may need to be done more than once.

Connect

The head unit will automatically connect to the last connected device when the connect feature is set to Auto connect On. If the connect feature is set to Auto Connect Off, the head unit will not automatically connect to any device.

Bluetooth Phone

From the main menu. Touch the **Bluetooth** on the screen. Bluetooth icon will appear anytime a Bluetooth device is connected.

Main Menu ①

Press icon to return to Main Menu screen.

Current Mode Indicator ②

Displays current mode of operation.

Bluetooth Status indicator ③

When Bluetooth is On and a Bluetooth device is being paired. The indicator will flash. When Bluetooth is On and a phone is connected to the unit. The indicator will illuminate steady.

Phone Keypad ④

Use the keypad to dial a phone number.

Call ⑤

Dial a number and touch the Phone icon to call.

Bluetooth Operation

- Devices** ⑥ Press the "DEVICES" to show the pairing device list. To connect to a previously connected device. Press the current device name. Any previously connected devices that are in range will be listed by their device name. Press the desired device name to disconnect from the current device and connect to the new device.
- Phone Book** ⑦ Press "CONTACTS" to access phone book menu.
- Call Log** ⑧ Press "CALL LOGS" to show(Dialed, Missed and Received Calls).
- Bluetooth Music** ⑨ Press "MUSIC" to initiate the Bluetooth music playback via A2DP.
- Setup** ⑩ Press "SETUP" to access Bluetooth settings.

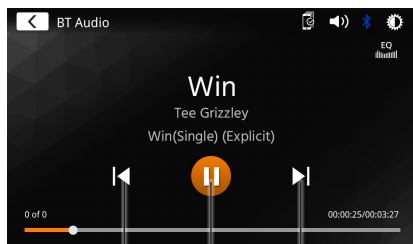

⑮

⑯

⑰

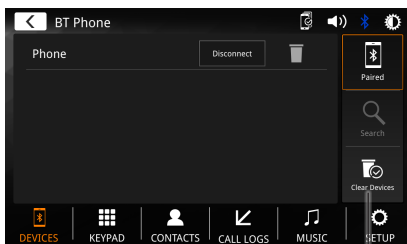

⑱

- End Call** ⑪ Press the End icon on screen or the End button on the Front panel to end a call in progress or to reject an incoming call.
- Audio Transfer Button** ⑫ Press to transfer audio between the unit and mobile phone.
- Microphone** ⑬ Turn the Microphone voice On or Off.
- Keypad** ⑭ Press to return to the Keypad screen.
- Track Down** ⑮ Press ◀ icon to return to the beginning of the current track.
- Play / Pause** ⑯ Press ▶/|| icon to pause or resume playback.
- Track Up** ⑰ Touch ▶ icon to skip ahead to the next song.
- Clear Devices** ⑱ Press ☒ icon to remove all paired Bluetooth devices or add new ones.

Driving Orientation Settings

To enhance the driving experience, the **SA&K+** allows the user to configure Apple CarPlay and Android for either Left Hand Drive (LHD) or Right Hand Drive (RHD) vehicles.

To select desired configuration, select either LHD or RHD from the Settings menu:

* Note: If you change the setting for Right Hand Drive mode or Left Hand Drive mode while the phone is connected to the receiver, disconnect the phone from the receiver and re-connect it again.

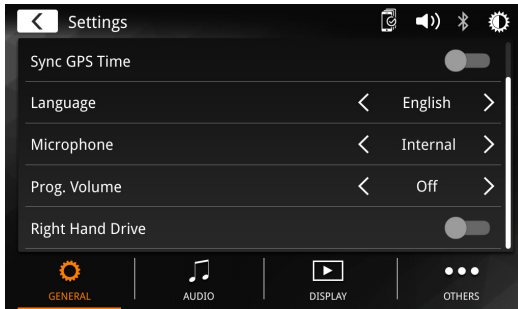

The resulting configuration options are shown below:

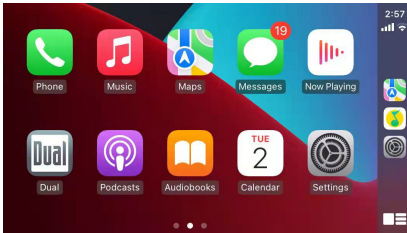

Apple CarPlay Left Hand Drive

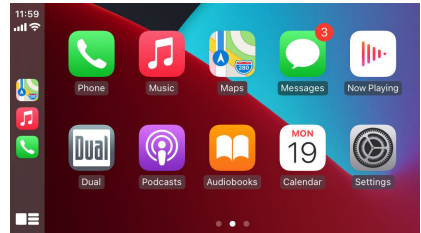

Apple CarPlay Right Hand Drive

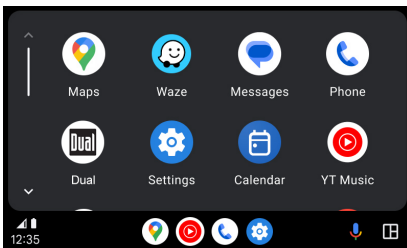

Compatible with Android Left Hand Drive

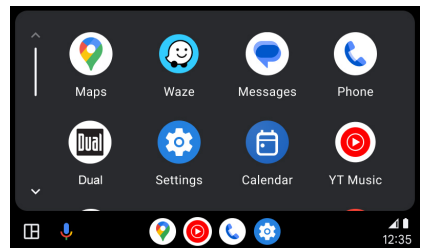

Compatible with Android Right Hand Drive

Wired & Wireless Apple CarPlay Operation

Wired connection

1. Connect an Apple CarPlay compatible device to this unit via USB.
2. Press the Apple CarPlay icon.
The Apple CarPlay home screen appears.

Wireless connection

Before using Apple CarPlay wirelessly, turn on the Bluetooth/Wifi function on the Phone.

1. Press  icon on the main menu;
2. Press "✓" to confirm to use wireless Apple CarPlay;
3. Press "🔍" icon to search phone device. The available devices appear on the list;
4. Find the desired device on the screen and press "Pair";
5. A pass key will be displayed on the screen;
6. The same key appears on the iPhone, press "Pair" and then press "Allow" for the popups;
7. Press "✓" on the screen to confirm to connect;
8. Press "Use CarPlay" on the iPhone. The unit configures the connection then starts the application.

Tip: Press  icon. Displays Apple CarPlay device list. This icon appears Only When Apple CarPlay is connected and two or more devices can be used as Apple CarPlay Source.

Wired & Wireless Android Operation

Wired connection

1. Connect an Android compatible device to this unit via USB.
2. Press the Android icon.
The Android home screen appears.

Wireless connection

Before using Android wirelessly, turn on the Bluetooth/Wifi function on the Android device.

1. Press  icon on the main menu;
2. Press "✓" to confirm to use wireless Android;
3. Press "🔍" icon to search phone device. The available devices appear on the list;
4. Find the desired device on the screen and press "Pair";
5. A pass key will be displayed on the screen;
6. The same key appears on the Android device, press "Pair" and then press "Allow" for the popups;
7. Press "✓" on the screen to confirm to connect;

The unit configures the connection then starts the application.

Tip: Press  icon. Displays Android device list. This icon appears Only When Android is connected and two or more devices can be used as Android Source.



Apple CarPlay Operation

Apple CarPlay is a smart interface for iPhone, allowing you to voice-control (via Siri) music, navigation, phone and messaging apps - significantly reducing driver distraction.



Phone - Use Siri to make calls, return missed calls, listen to voicemail messages, and view the caller ID on the receiver's screen.



Messages - Ask Siri to send, read, and reply to text messages. This hands free operation minimizes distraction and allows you to keep hands on the wheel and eyes on the road.



Music - Access music by artist, song, playlist, and more through the receiver's touchscreen or via Siri. The receiver will mirror the iPhone screen with artist and track information.



Maps - Use Siri to request turn-by-turn directions – search by address or points of interest. Apple Maps will be mirrored on the screen, including traffic information and estimated time to destination.

Compatible Devices

Made for iPhone models:

iPhone15, iPhone 15 Plus, iPhone 15 Pro, iPhone 15 Pro Max, iPhone14, iPhone 14 Plus, iPhone 14 Pro, iPhone 14 Pro Max, iPhone 13 mini, iPhone 13, iPhone 13 Pro, iPhone 13 Pro Max, iPhone 12 mini, iPhone 12, iPhone 12 Pro, iPhone 12 Pro Max, iPhone 11 Plus, iPhone 11, iPhone XS Max, iPhone XS, iPhone XR, iPhone X, iPhone 8, iPhone 8 Plus, iPhone 7, iPhone 7 Plus, iPhone 6, iPhone 6S

Starting Apple CarPlay

Wireless Apple CarPlay Connection Description.

1. Enter the main UI and click BT Phone to enter the Bluetooth interface;
2. Click Refresh to search nearby Bluetooth, click Pair to match Bluetooth;
3. Open the iPhone WLAN to connect to the car, after the connection is successful, the Apple CarPlay icon in the device list will appear, and the Apple CarPlay connection is successful;
4. Enter the Apple CarPlay interface, click the functions of Phone/ Music/Map/Information/etc.

Note: For safety reasons, Apple CarPlay features are limited while driving and will vary with each Apple CarPlay-enabled app. Available functions are determined by each individual app provider. For more information, visit www.apple.com/ios/carplay.

Note: Certain iPhone functions may be illegal while driving in your location. Be sure to familiarize yourself with local and state laws regarding mobile devices. When in doubt, stop and park your vehicle before using any devices.

Apple CarPlay Operation

When the Apple CarPlay menu is displayed, the home button in the lower left corner work just like the home button on your iPhone.

- ⊙ Press and hold it to summon Siri and begin your voice commands.
- ⊙ At any time during Apple CarPlay operation, you can press this button momentarily to return to the main Apple CarPlay menu screen.

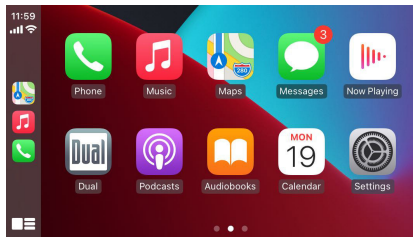

Press any Application button on the main Apple CarPlay menu to access that operation directly. The toolbar on the left side of the screen displays the time, signal strength and shortcuts to the most popular applications - Phone, Music and Navigation - so they can be accessed quickly and easily without returning to the main menu.

Controlling Apple CarPlay

The following basic controls will operate many standard Apple CarPlay features.



Touch - Briefly press the desired option.



Swipe - Briefly swipe in the desired direction.



Drag - Press, hold and drag to the desired location.

Note: There is no need to pair your iPhone when using Apple CarPlay. This will occur automatically when connecting an iPhone to the unit's USB port.

Note: When Apple CarPlay is in use, the unit's Bluetooth will turn off automatically and hands-free functionality will operate through the Apple CarPlay feature. Any other devices connected via Bluetooth will be disconnected during Apple CarPlay use.

Exiting Apple CarPlay

Disconnecting your iPhone will automatically exit Apple CarPlay mode. To exit Apple CarPlay mode while your phone is still connected, press the Power/Volume knob momentarily, and the unit's main menu will be displayed.



Android Operation

Android brings the most useful apps to your phone screen or your compatible car display, in a format that makes it easy for you to keep your main focus on driving. You can control things like navigation and maps, calls and text messages, and music.

Google Assistant

With your Google Assistant on Android, you can keep your eyes on the road and your hands on the wheel while using your voice to help you with your day. Simply say, "Ok Google," or in compatible cars, long press the voice control button on your steering wheel.

Navigation

Get real-time traffic alerts to avoid hazards, speed traps, and find the fastest route. Or take a break and find a bite along the way.

Calls & Messages

Your Google Assistant lets you stay connected while you're driving. Your Assistant can help you call phone numbers from your contacts, chat with your favorite apps, read your messages aloud and text back, keeping your hands on the wheel.

Compatible Devices

Android requires the Android Auto app from Google Play installed on an Android smartphone running Android Lollipop 5.0 or higher.

Warning:

Certain uses of the smartphone may not be legal while driving in your jurisdiction, so you must be aware of and obey any such restrictions. If in doubt as to a particular function, only perform it while the car is parked. No feature should be used unless it is safe to do so under the driving conditions you are experiencing.

Starting Android

Wireless Android Connection Description.

1. Enter the main UI and click BT Phone to enter the Bluetooth interface;
2. Click Refresh to search nearby Bluetooth. You'd better turn on your Phone's WLAN before you connect to Bluetooth, otherwise the connection will fail;
3. Click Pair to match Bluetooth, then there will be a notification to select settings and select your mobile Phone, and the Android connection is successful;
4. Enter the Android interface, click the functions of Phone/ Music/Map/Information/ etc.

Note: When the device for Android is connected to this unit, the device is also connected via Bluetooth at the same time. If five devices are already paired, the message confirming whether to delete the registered device is displayed. If you want to delete the device, touch [Agree]. If you want to delete other device, touch [BT Settings] and delete the devices manually.

Note: If Android Auto is turned on during a call on a cellular phone other than the Android compatible device, the Bluetooth connection will switch to the Android compatible device after the call.

Android Operation

Using Android

The Android home screen displays personalized information, like time to your destination, reminders, recent calls incoming messages, the song you're listening to, and Google Now cards.

When the Android menu is displayed, you can say "OK Google" or select the microphone in the upper right corner to talk to Google.

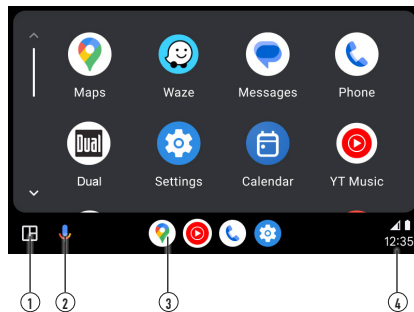

- ① Android Home Button
- ② Activate Google Assistant™
- ③ Recent Apps
- ④ Notification Button

Exiting Android

To exit Android, press the Exit button. Disconnecting your Android phone will automatically exit Android mode.



DMD7W INSTALLATION

Change to Register Your Product

General		
Problem	Cause	Action
Unit will not turn on (no power)	Incorrect voltage	Check connections for proper voltage (12V Adapter)
	Loose connecting wire	Check if the power cord is loose or dropped
Difficulty in Adhesion to On-Dash Surface	Presence of Dust on the Silicon Cover or On-Dash	Ensure thorough dust removal before installation.

For Your Records

Please keep your original sales receipt and be prepared to provide this receipt in the event you require service, as your original receipt is considered the best proof of purchase and indicates the date you purchased your Dual product.

Dealer Name _____

Dealer Phone _____

Purchase Date _____

Register Your Product

Register your product online at www.dualav.com.

Extend your warranty from 1 year to 2 years when you register online at www.dualav.com.

Specifications

Monitor	Panel size: 7" Touchscreen Resolution: 1024 (H) x 600 (V)
Phone Connectivity	Connection method: Wired / Wireless
Rear USB	Compatibility: High Speed USB 2.0 USB Class: Mass storage class
General	Car Connectivity: Broadcast to FM Station or 3.5mm Aux Output Mounting Options: Suction Cup for Dash or Windshield Power: 12V Adapter Bluetooth Features: Internal and External Microphones Built-in Speaker: Yes Design and specifications subject to change without notice.
Cigar Adapter Spec :	Power Supply Voltage Range : DC12V ~ 16V(Negative Ground) 5V / 2.1A Charging (USB Port Only) 6Pin Din Plug to Unit



Limited One Year* Warranty

This warranty gives you specific legal rights. You may also have other rights which vary from state to state.

Dual Electronics Corp. Inc warrants this product to the original purchaser to be free from defects in material and workmanship for a period of one year from the date of the original purchase.

Dual Electronics Corp. Inc agrees, at our option, during the warranty period, to repair any defect in material or workmanship or to furnish an equal new, renewed or comparable product (whichever is deemed necessary) in exchange without charges, subject to verification of the defect or malfunction and proof of the date of purchase. Subsequent replacement products are warranted for the balance of the original warranty period.

Who is covered? This warranty is extended to the original retail purchaser for products purchased from an authorized Dual dealer and used in the U.S.A.

What is covered? This warranty covers all defects in material and workmanship in this product. The following are not covered: software, installation/removal costs, damage resulting from accident, misuse, abuse, neglect, product modification, improper installation, incorrect line voltage, unauthorized repair or failure to follow instructions supplied with the product, or damage occurring during return shipment of the product. Specific license conditions and copyright notices for the software can be found via www.dualav.com.

Warranty Coverage

* Limited 1-year warranty. (Proof of purchase required)

Extend your warranty from 1 year to 2 years when you register online at www.dualav.com.

What to do?

1. Before you call for service, check the troubleshooting guide in your owner's manual. A slight adjustment of any custom controls may save you a service call.
2. If you require service during the warranty period, you must carefully pack the product (preferably in the original package) and ship it by prepaid transportation with a copy of the original receipt from the retailer to an authorized service center.
3. Please describe your problem in writing and include your name, a return UPS shipping address (P.O. Box not acceptable), and a daytime phone number with your shipment.
4. For more information and for the location of the nearest authorized service center please contact us by one of the following methods:
 - Call us toll-free at 1-866-382-5476
 - E-mail us at cs@dualav.com

Exclusion of Certain Damages: This warranty is exclusive and in lieu of any and all other warranties, expressed or implied, including without limitation the implied warranties of merchantability and fitness for a particular purpose and any obligation, liability, right, claim or remedy in contract or tort, whether or not arising from the company's negligence, actual or imputed. No person or representative is authorized to assume for the company any other liability in connection with the sale of this product. In no event shall the company be liable for indirect, incidental or consequential damages.



Dual Electronics Corp.
Toll Free: 1-866-382-5476
Monday-Friday, 9AM-5PM EST
www.dualav.com
©2024 Dual Electronics Corp. All rights reserved.

NSA0124-01