



DVD



Mechless

# DVN927BT

## INSTALLATION/OWNER'S MANUAL

DVD Multimedia Receiver with Bluetooth®  
featuring a 6.2" Touch Screen Display



Bluetooth®



### Safety Notes: (Only DVD Receiver)

The DVD video display of the in-dash unit will not operate while the vehicle is moving. This is a safety feature to prevent driver distraction. In-dash DVD video functions will only operate when vehicle is in Park and the parking brake is engaged. It is illegal in most states for the driver to view video while the vehicle is in motion.

**Copyright Notes**

This product incorporates copyright protection technology that is protected by method claims of certain U.S. patents and other intellectual property rights owned by Macrovision Corporation and other rights owners. Use of this copyright protection technology must be authorized by Macrovision Corporation, and is intended for home and other limited viewing uses only unless otherwise authorized by Macrovision Corporation. Reverse engineering or disassembly is prohibited.

DVD Logo is a trademark of DVD Format/ Logo Licensing Corporation registered in the U.S., Japan and other countries.

The Bluetooth® word mark and logos are owned by the Bluetooth SIG, Inc.

Other trademarks and trade names are those of their respective owners.

## Table of Contents

	Page
Warning Statement .....	3
Safety Information/Precautions .....	4
Preparation/Mounting .....	5
Wiring Diagram .....	6
Control Locations .....	7
Remote Preparation .....	8
General Operation .....	9-11
AM/FM Tuner Operation .....	12-13
CD/USB Operation .....	13
Media Compatibility .....	14-16
DVD Operation .....	17-18
Bluetooth Operation .....	19-20
iPod Operation .....	21
Navigation Operation / Auxiliary Inputs/Rear Camera Operation .....	22
SWC Input Operation .....	23
Dual iPod APP Operation .....	24
Specifications .....	25
Warranty .....	26
Troubleshooting .....	27



## DVN927BT PREPARATION

---

### **WARNING**

Upon installation of this Monitor/DVD player ("unit") into a vehicle, the driver of the vehicle must not operate this unit by watching videos or playing video games while driving. Failure to follow this instruction could lead to driver distraction which could result in serious injury or death to the vehicle's occupants or persons outside the vehicle and/or property damage.

Several states prohibit the installation of monitors/DVD players if the screen is visible from the driver's seat. If you reside in a jurisdiction which has enacted such a law, this unit must not be installed so that the screen is visible from the driver's seat. When installing this unit in the front console/dashboard, the unit must be positioned so that it is facing the front passenger seat only. Failure to follow this instruction could lead to driver distraction which could result in serious injury or death to the vehicle's occupants or persons outside the vehicle and/or property damage.

This unit is designed so that it may be operated only when the vehicle is in "Park" and the parking brake is fully engaged. To this end, this unit includes a parking brake lock-out feature which prohibits the unit from operating if the vehicle is not in "Park" and/or the parking brake is not fully engaged. When installing this unit, the installer must connect the parking brake detect wire to the parking brake mechanism in order to make the parking brake lock-out feature operable. DO NOT simply ground the parking brake detect wire to a metal portion of the vehicle. Failure to properly install the parking brake lock-out feature could lead to driver distraction which could result in serious injury or death to the driver's occupants or persons outside the vehicle and/or property damage.

Once the parking brake lock-out feature is installed, the owner/user must not attempt to disrupt/neutralize the parking brake lock-out feature by (a) partially engaging the parking brake and/or (b) purchasing/using any device or unit designed to send necessary brake signals to the unit. Failure to follow these instructions could lead to driver distraction which could result in serious injury or death to the driver's occupants or persons outside the vehicle and/or property damage.

When operating this unit, keep the unit's volume level low enough so that the vehicle's occupants can hear traffic-related sounds such as police and emergency vehicles. Failure to follow this instruction could lead to driver distraction which could result in serious injury or death to the vehicle's occupants or persons outside the vehicle and/or property damage.

**\* Note**

The above video Content is for DVD Receiver Only.

## Safety Information

Please read all instructions carefully before attempting to install or operate.

Due to its technical nature, it is highly recommended that your DUAL DV927BT is installed by a professional installer or an authorized dealer. This product is only for use in vehicles with 12VDC negative ground only.

To prevent damage or injury:

- Make sure to ground the unit securely to the vehicle chassis ground.
- Do not remove the top or bottom covers of the unit.
- Do not install the unit in a spot exposed to direct sunlight or excessive heat or the possibility of water splashing.
- Do not subject the unit to excessive shock.
- When replacing a fuse, only use a new one with the prescribed rating. Using a fuse with the wrong rating may cause the unit to malfunction.
- To prevent short circuits when replacing a fuse, disconnect the wiring harness first.
- Use only the provided hardware and wire harness.
- You cannot view video while the vehicle is moving. Find a safe place to park and engage the parking brake.
- If you experience problems during installation, consult your nearest DUAL dealer.
- If the unit malfunctions, reset the unit as described on page 10 first. If the problem still persists, consult your nearest DUAL dealer or call tech assistance @ 1-866-382-5476.
- To clean the monitor, wipe only with a dry silicone cloth or soft cloth. Do not use a stiff cloth, or volatile solvents such as paint thinner and alcohol. They can scratch the surface of the panel and/or remove the printing.
- When the temperature of the unit falls (as in winter), the liquid crystal inside the screen will become darker than usual. Normal brightness will return after using the monitor for a while.
- When extending the ignition, battery or ground cables, make sure to use automotive-grade cables or other cables with an area of 0.75mm (AWG 18) or more to prevent voltage drops.
- Do not touch the liquid crystal fluid if the LCD is damaged or broken. The liquid crystal fluid may be hazardous to your health or fatal. If the liquid crystal fluid from the LCD contacts your body or clothing, wash it off with soap immediately.

### FCC Compliance

This device complies with Part 15 of the FCC Rules. Operation is subject to the following two conditions:

- (1) this device may not cause harmful interference, and
- (2) this device must accept any interference received, including interference that may cause undesired operation.

**Warning:** Changes or modifications to this unit not expressly approved by the party responsible for compliance could void the user's authority to operate the equipment.

**Note:** This equipment has been tested and found to comply with the limits for a Class B digital device, pursuant to Part 15 of the FCC Rules. These limits are designed to provide reasonable protection against harmful interference in a residential installation. This equipment generates, uses and can radiate radio frequency energy and, if not installed and used in accordance with the instructions, may cause harmful interference to radio communications. However, there is no guarantee that interference will not occur in a particular installation. If this equipment does cause harmful interference to radio or television reception, which can be determined by turning the equipment off and on, the user is encouraged to try to correct the interference by one or more of the following measures:

- Reorient or relocate the receiving antenna.
- Increase the separation between the equipment and receiver.
- Connect the equipment into an outlet on a circuit different from that to which the receiver is connected.
- Consult the dealer or an experienced radio/TV technician for help.

## Preparation

### Before You Start

- Disconnect negative battery terminal. Consult a qualified technician for instructions.
- Avoid installing the unit where it would be subject to high temperatures, such as from direct sunlight, or where it would be subject to dust, dirt or excessive vibration.

### Getting Started

- Connect wiring harness as shown on page 6. Consult a qualified technician if you are unsure.
- Certain vehicles may require an installation kit and/or wiring harness adapter (sold separately).
- Reconnect negative battery terminal, and test for correct operation.
- Snap trim ring into place (if required).
- Slide unit into mounting sleeve to secure.

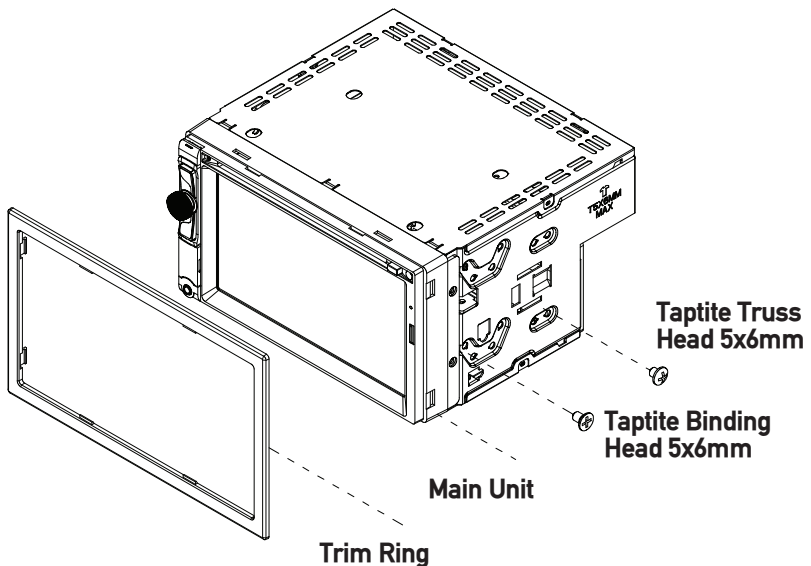

**TYPICAL FRONT-LOAD DIN MOUNTING METHOD**

## Wiring Diagram - Inputs/Outputs

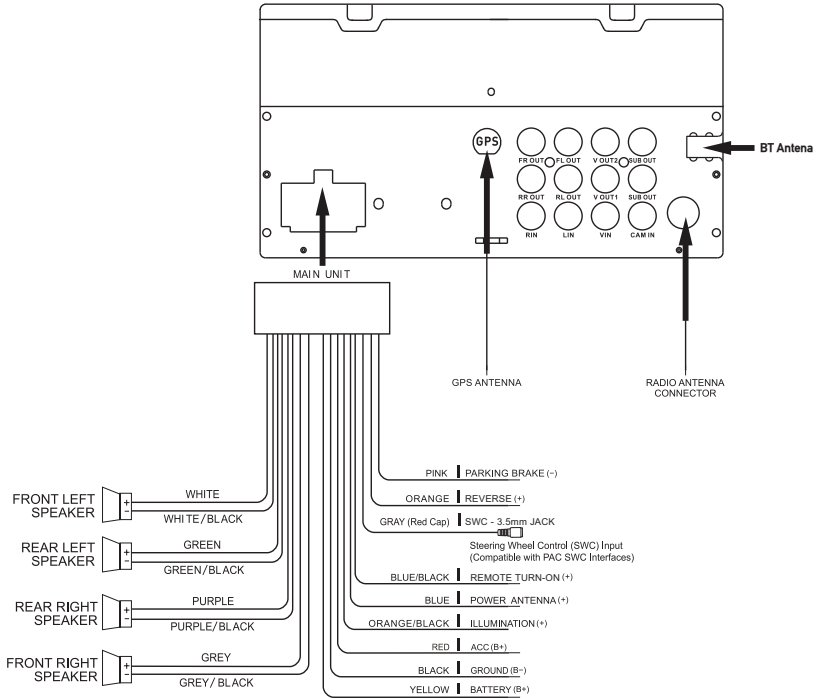

### Note:

When replacing a fuse, make sure to use the correct type and amperage. Using an incorrect fuse could cause damage. The unit uses (1) 10 amp ATM mini style fuse located on the power connector.

### Wiring Notes:

#### Subwoofer output

The Subwoofer preamp audio output (black jacket with green RCA) is active in all audio modes.

#### Rear camera input

A rear view camera (not included) can be used with the Camera input.



# DVN927BT OPERATION

## Control Locations



- |              |                         |                   |
|--------------|-------------------------|-------------------|
| ① microSD    | ⑤ Navigation            | ⑨ USB Port        |
| ② Microphone | ⑥ Tune/Track Up         | ⑩ Auxiliary Input |
| ③ Eject      | ⑦ Power / Volume / Mute |                   |
| ④ Reset      | ⑧ Tune / Track Down     |                   |

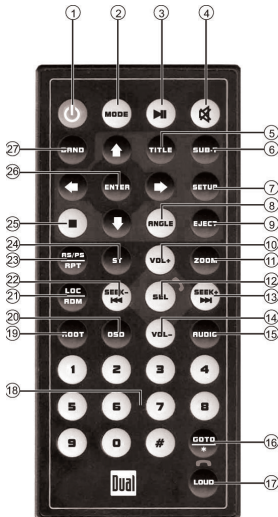

- |                        |                              |
|------------------------|------------------------------|
| ① Power                | ⑮ Audio                      |
| ② Mode                 | ⑯ Go To / *                  |
| ③ Play / Pause         | ⑰ Loudness / End Call        |
| ④ Mute                 | ⑱ Number Keys                |
| ⑤ Title                | ⑲ Root                       |
| ⑥ Subtitle             | ⑳ OSD (On Screen Display)    |
| ⑦ Setup                | ㉑ Local / Random             |
| ⑧ Angle                | ㉒ Seek Down / Previous Track |
| ⑨ Eject                | ㉓ AS/PS / Repeat             |
| ⑩ Volume Up            | ㉔ Stereo                     |
| ⑪ Zoom                 | ㉕ Stop                       |
| ⑫ Select / Talk        | ㉖ Enter                      |
| ⑬ Seek Up / Next Track | ㉗ Band                       |
| ⑭ Volume Down          |                              |



# Remote Control Preparation

Remove battery insulation tape .

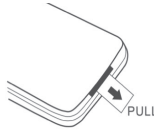

To insert or replace the battery, remove the battery holder.

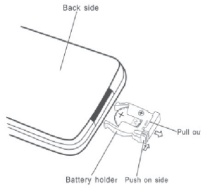

Remove the battery from the battery holder.

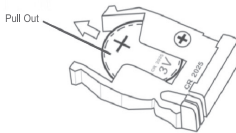

Install the new battery.  
Make sure to keep the (+) side up.



Insert the battery holder .

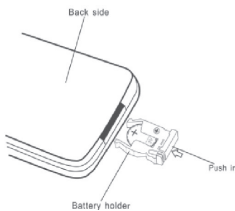

Notes:

- The remote control uses one 3 volt Lithium CR2025 battery. Remove the battery if the remote will not be used for a month or longer.
- Remove and dispose of battery properly.
- Do not store battery with metallic objects or materials.





# DVN927BT OPERATION

## General Operation

<b>Power On/Off</b>	Momentarily press  to turn the unit on or off.
<b>Volume</b>	Rotate the volume knob to increase or decrease the volume level.
<b>Mute</b>	Momentarily press <b>MUTE</b> to silence the audio. Momentarily press <b>MUTE</b> again to return to the previously selected volume. Rotating the <b>volume knob</b> while the volume is muted will also cancel the mute function.
<b>Mode</b>	Press <b>MODE</b> to step through all available input modes: Radio, Disc (which includes DVD and CD playback), Navigation, AV In, iPod, Bluetooth Phone, Bluetooth Music, Auxiliary Input, Rear Camera and Settings. Modes of operation are indicated on the display and/or the monitor. Optional iPod device must be connected/inserted to appear in the mode selection string.
<b>Auxiliary Input</b>	Connect external audio/video devices to the 3.5mm auxiliary input on the front panel.
<b>iPod</b>	Connect an iPod device to play MP3 files.
<b>MicroSD Card</b>	For navigation use only. Contains microSD card with navigation software. Do not remove microSD card. Do not delete / modify SD card folder structure.
<b>Main Menu</b>	Press the house icon in the top left corner to access the Main Menu screen.

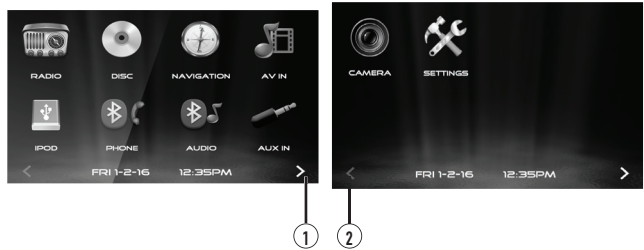

1. Next screen
2. Previous screen

<b>Reset</b>	To resolve abnormal operation or if the unit is inoperable, use the tip of a pen to press the <b>RESET</b> button (located behind the faceplate). The unit will reset the main processor to the default settings.
--------------	---

## General Operation

### Setup Menu

From the Main Menu screen, select **Settings** to access the Setup menu and select from five categories represented by the icons on the left side of the screen: General, Language, Audio, Screen and Bluetooth. Select the desired sub-menu, and adjust using the up/down arrows on the right side of the screen. To return to the previous screen, use the arrow in the upper right corner of the screen.

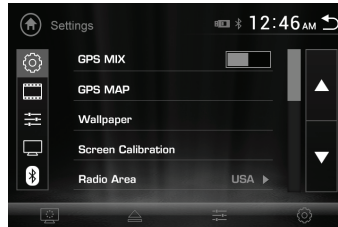

#### General:

- **GPS Mix** - Turn On or Off.
- **GPS Map** - Select Mobile Navigator.
- **Wallpaper** - Select one of three wallpaper options.
- **Screen Calibration** - Follow the prompts to calibrate the touch screen.
- **Radio Area** - Adjust the following radio options: Europe, USA, South America, Russian and Asia.
- **Time Setting** - Access and adjust date and time settings.
- **Beep** - Turn the audible beep on or off.
- **Camera** - Turn the rear camera input on or off.
- **Version** - View current version numbers for the unit.
- **Restore default** - Press to restore unit to factory settings.

#### Language:

- **Audio Language** - Select a language option for the unit's audio.
- **Subtitle Language** - Select a language for subtitles (or select to turn subtitles off).
- **Menu Language** - Select a language option for the unit's menu options.

#### Audio:

- **Audio Adjustment** - Adjust EQ, Surround Sound or Balance/Fader settings.
- **Subwoofer** - Press to adjust subwoofer frequency and volume.
- **Loudness** - Press to turn Loudness feature on or off.
- **Loudness Cutoff Frequency** - When the Loudness feature is activated, press to set the Loudness cutoff frequency to 400Hz, 800Hz or 2400Hz.

#### Screen:

- **Aspect Ratio** - Select between 4:3PS, 4:3LM or 16:9.
- **Adjust** - Adjust Brightness, Contrast, Hue, Saturation and Sharpness.
- **Panel** - Adjust Backlight settings, or turn Backlight off.

#### Bluetooth:

- **Auto Connect** - Turn Auto Connect feature on or off.
- **Auto Answer** - Turn Auto Answer feature on or off.

## General Operation

### Touch Screen Controls

The touch screen controls on the bottom of each screen allow direct access to important features during any mode of operation.

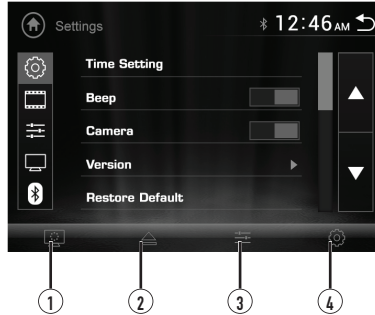

- Standby** ① Press to dim the display or put the unit in Standby mode.
- Eject** ② Press to eject the disc.
- Audio** ③ Press to adjust audio options such as EQ, Surround Sound and Balance/Fader.
- Settings** ④ Press to access the settings menu.

## AM/FM Tuner Operation



**Radio Operation** | Select the Radio icon from the Main Menu screen.

**Main Menu** (1) | Press to return to Main Menu screen.

**Current Mode Indicator** (2) | Displays current mode of operation.

**Tune Frequency Down** (3) | Press << to tune radio to a lower frequency. Press < to tune the unit down one step at a time.

**Band** (4) | Press between 2 AM and 3 FM bands.

**Local / Distance** (5) | Press to toggle between Local and Distance tuning.

**Tune Frequency Up** (6) | Press >> to tune radio to a higher frequency. Press > to tune the unit up one step at a time.

**AS/PS** (7) | Press to scan presets and listen to the first 10 seconds of each. Press again to stop scanning and listen to the station. Press and hold to automatically find and store the strongest stations as presets.

**Stereo** (8) | Press to toggle between Stereo and Mono tuning.

**Preset Stations** (9) | Press and hold to set the current station in that preset spot. Press momentarily to recall the desired preset and begin playback.

## CD/USB Operation

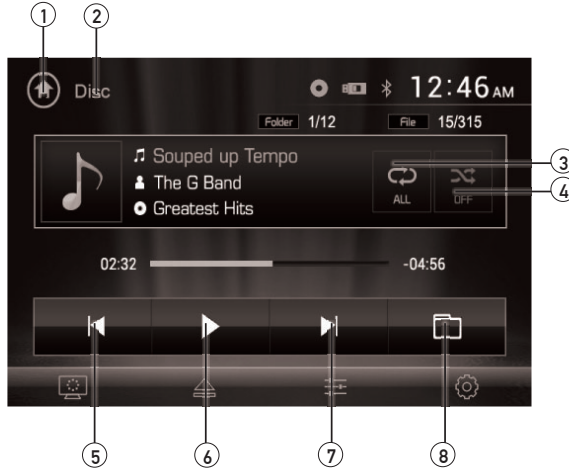

### CD/USB Operation

To play audio files from a disc or MP3 files from a disc or USB device, insert disc or device and playback will begin automatically. To return to disc or USB playback from another mode of operation, select the corresponding icon from the Main Menu.

- **Disc Playback** - Insert disc into the slot, and playback will begin automatically.
- **USB Playback** - Insert a USB device into the USB slot on the side of the unit.

- Main Menu ①** Press to return to Main Menu screen.
- Current Mode Indicator ②** Displays current mode of operation.
- Repeat ③** Press to select a repeat option: Repeat 1, Repeat Folder or Repeat Off.
- Random ④** Press to enable or disable random playback.
- Previous File / Track ⑤** Press to go back to the previous file or track.
- Play / Pause ⑥** Press to pause or resume playback.
- Next File / Track ⑦** Press to advance to the next file or track.
- Folder Access ⑧** Press to access all folders on device.

## Media Compatibility

<b>Media Compatibility</b>	<p>The following types of discs/files are compatible:</p> <ul style="list-style-type: none"> <li>• CD-DA, CD-ROM (ISO), CD-R, CD-RW</li> <li>• DVD Video, DVD+R/RW, DVD-R/RW</li> </ul> <p>The following types of discs/files are not compatible:</p> <ul style="list-style-type: none"> <li>• WMA files that are protected by DRM (Digital Rights Management)</li> <li>• WMA lossless format</li> <li>• Discs recorded with Track At Once or packet writing</li> <li>• MP3 PRO format, MP3 playlists</li> <li>• RMP format</li> <li>• WAV format</li> <li>• WMV format</li> <li>• AAC, protected AAC, M4V, M4A format</li> </ul> <p>Some recordable DVD's and CD's may be incompatible with this unit, depending on media type and recording method.</p>
<b>Playback Order</b>	<p>MP3 playback sequence begins in the root folder of the disc or USB flash drive. Any empty folders or folders that do not include MP3 files are skipped.</p>
<b>Compatible Recording Formats</b>	<p>ISO9660 standards:</p> <ul style="list-style-type: none"> <li>• Maximum nested folder depth is 8 (including the root folder).</li> <li>• Valid characters for folder/file names are letters A-Z (all caps), numbers 0-9, and "_" (underscore). Some characters may not be displayed correctly, depending on the character type.</li> <li>• This device can play back discs in Joliet and other standards that conform to ISO9660. MP3 written in the formats other than the above may not play and/or their file names or folder names may not be displayed properly.</li> </ul>
<b>Notes</b>	<p>Some files may not play or be displayed correctly, depending on sampling rates and bit rates.</p> <p>For best results, use the following settings when ripping MP3 files: 128kbps or higher constant bit rate 44.1kHz or higher sampling frequency</p>

## DVD Operation

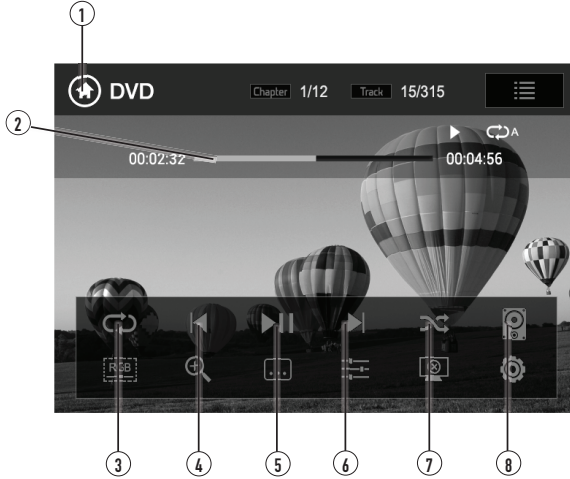

### Inserting a Disc

Insert disc into the slot, and playback will begin automatically. Sub-menus may have to be pressed to access the DVD content. Read the directions of your specific DVD disc for other features.

### Ejecting the Disc

Press  to eject the disc.

### Touchscreen Controls

Press anywhere on the LCD to display touch screen controls.

#### Main Menu

Press to return to Main Menu screen.

#### Elapsed Time

Displays elapsed time and time remaining on the DVD.

#### Repeat

Press to select from the following repeat options: Repeat Chapter, Repeat Title, Repeat All or Repeat Off

#### Previous Chapter

Press to return to the previous chapter on the DVD.

#### Play / Pause

Press to play or pause DVD playback.

#### Next Chapter

Press to advance to the next chapter.

#### Random

Press Random to play chapters in random order or Random Off to play disc in order.

#### Audio

Press to adjust audio language settings.



## DVD Operation



- Screen Setup** (9) Press to adjust screen color settings.
- Zoom** (10) Press to zoom in or out on an image.
- Subtitle** (11) Press to access subtitle options.
- Audio** (12) Press to adjust audio options.
- Monitor On/Off** (13) Press to put the monitor in standby mode.
- Settings** (14) Press to directly access the setup menu.

## Bluetooth Operation



### Preparation

Before you can use a Bluetooth device, it must be paired and connected. Make sure that Bluetooth is activated on your device before you begin the pairing process.

### Pairing a New Device

The unit broadcasts the pairing signal constantly when no devices are currently connected. Complete the pairing sequence from your Bluetooth device. Refer to the owner's manual for your device for more details. **The device name is "DV927BT". The Bluetooth passcode is "0000".** The unit can be in any mode of operation when pairing is performed. On certain phones, pairing may need to be done more than once.

### Connecting a Paired Device

Most Bluetooth devices support the auto-connect feature and will connect automatically if the device is in range when the unit is powered-on. If your device was previously paired but does not connect, enter the Bluetooth setup menu and ensure that Auto Connect is On.

### Bluetooth Phone

To access the phone, select Bluetooth Phone from the Main Menu or press the phone icon from any operational mode.

### Main Menu (1)

Press to return to the Main Menu screen.

### Current Mode Indicator (2)

Displays current mode of operation.

### Phone Keypad (3)

Use the phone keypad to dial the desired phone number. Alternately, numbers can be dialed directly from the phone.

### Bluetooth Phone (4)

Press to access Bluetooth phone.

### Bluetooth Music (5)

Press to access Bluetooth music.

### Available Devices (6)

Press to view a list of available devices.

### Talk (7)

Press to connect a call.

### End Call (8)

Press to end a call.

## Bluetooth Operation



9

10

11

12

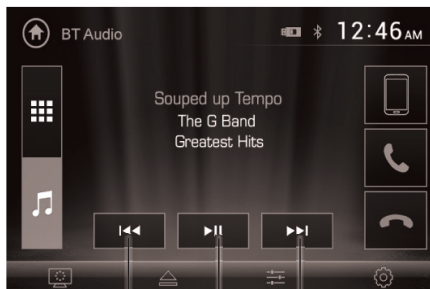

13

14

15

**Standby** 9 Press to put the monitor into standby mode.

**Eject** 10 Eject the disc.

**Audio** 11 Press to adjust Audio options.

**Settings** 12 Press to access the Settings menu.

**Bluetooth Music** Press to display the keypad and make a call.

**Previous File / Track** 13 Press to go back to the previous file or track.

**Play / Pause** 14 Press to pause or resume playback.

**Next File/Track** 15 Press to advance to the next file or track.

## iPod Operation



- |                                  |  |
|----------------------------------|--|
| <b>Connecting an iPod Device</b> | Connect an iPod device to the unit's USB port.                                 |
| <b>Main Menu</b> ①               | Press to return to the Main Menu screen.                                       |
| <b>Current Mode Indicator</b> ②  | Displays current mode of operation.  |
| <b>Repeat</b> ③                  | Press to select a repeat option: Repeat 1, Repeat All (default) or Repeat Off. |
| <b>Random</b> ④                  | Press to enable or disable random playback.                                    |
| <b>Previous File / Track</b> ⑤   | Press to go back to the previous file or track.                                |
| <b>Play / Pause</b> ⑥            | Press to pause or resume playback.   |
| <b>Next File / Track</b> ⑦       | Press to advance to the next file or track.                                    |

## Navigation Operation

### Navigation Operation

To access navigation functions, select Navigation from the Main Menu. For questions regarding navigation operation, refer to the Navigation manual available online at [dualav.com/support/manuals.php](http://dualav.com/support/manuals.php).

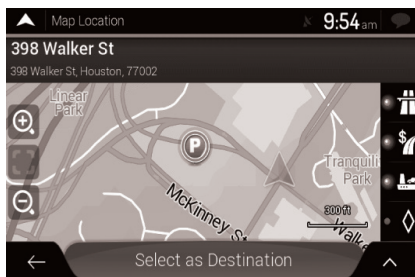

## Front 3.5mm Aux Input & Rear RCA A/V Input

### Auxiliary Input

Connect an optional audio source into the 3.5mm (front panel) input. Select auxiliary input from the Main Menu to listen to audio. Adjust volume on the external audio source as needed (if connected to the headphone output of the device).

### Using AV Input

Connect an optional audio/video source to the rear auxiliary input (Red/White/Yellow RCA connectors). Refer to page 6 for details. Select AV Input from the Main Menu to listen to audio. Engage parking brake to watch video.

## Rear Camera Operation - (Optional)

### Using Rear Camera

Connect an optional rear camera to the Camera Input (Black RCA connector). Refer to the wiring diagram for details.

Manual selection - Touch CAMERA icon from the Main Menu or from any operational mode (when enabled) to select camera mode. Touch the top left area on the screen to exit camera mode.

**Note:** The manual mode is for dedicated cameras that are ALWAYS on while driving, it is not meant for cameras that are connected to the vehicle's reverse light.

### Auto Selection

The unit will automatically select camera mode when connected to the reverse lamp circuitry.

**Note:** The external video output is not active when using the rear camera input.



## SWC Input Operation

The built-in SWC Interface is compatible with PAC steering wheel control modules. The PAC SWI-RC is recommended. A third-party adapter must be used in order for the DV927BT to be compatible with any steering wheel controls. The following controls are available for most vehicles.

1. Volume Up (+)	4. Preset (+)	7. Seek/Track Up (+)	10. BT Talk
2. Volume Down (-)	5. Preset (-)	8. Seek/Track Down (-)	11. BT End
3. Mute	6. Mode	9. Band	

**Note:** Not all OE steering wheel functions may be supported by the XDVD276BT.

## PAC SWI-RC Installation Hints

1. Set "Radio Select Switch". Set the SWI-RC to position 7 - "Pioneer/Other/Sony".
2. To program, use the Pioneer/Sony/Other radio function mapping order for Dual units.
3. When programming the SWI-RC, if a function is not supported (or not desired), then the function **MUST** be skipped as per the PAC SWI-RC instructions.
4. The SWC function **MUST** be programmed in the correct order per the PAC SWI-RC radio function mapping order instructions.

Function Order	Function Mapping	SWI-RC (3.3VDC Reference)	
		Center Pin (Ring) Voltage (Function Select)	Tip Pin Voltage
1	Volume +	H 5.0v	2.07
2	Volume -	H 5.0v	2.32
3	Mute	H 5.0v	1.01
4	Preset +	L 0.0V	1.54
5	Preset -	L 0.0V	1.81
6	Source	H 5.0v	0.60
7	Seek + / Track +	H 5.0v	1.54
8	Seek - / Track -	H 5.0v	1.81
9	Band	H 5.0v	2.73
10	BT Talk	L 0.0V	0.60
11	BT End	L 0.0V	1.01

## Dual iPlug App Operation

The Dual iPlug™ Smart App is the ultimate wireless remote control for your multimedia receiver.

You can download the Dual iPlug app from Apple Appstore or Google Playstore and install it on your smartphone or tablet.



Dual iPlug





## DVN927BT OPERATION

# Specifications

<b>Disc</b>	Frequency response: <b>20Hz-20kHz</b> Channel separation @ 1kHz: <b>&gt;80dB</b> D/A converter: <b>24 Bit</b>
<b>FM Tuner</b>	Tuning range: <b>87.5MHz-107.9MHz</b> Usable sensitivity: <b>10dBf</b> 50dB quieting sensitivity: <b>20dBf</b> Stereo separation @ 1kHz: <b>38dB</b> Frequency response: <b>30Hz-13kHz</b>
<b>AM Tuner</b>	Tuning range: <b>530kHz-1710kHz</b> Usable sensitivity: <b>24uV</b> Frequency response: <b>30Hz-2.3kHz</b>
<b>Front USB</b>	Compatibility: <b>High Speed USB 2.0</b> USB Class: <b>Mass storage class</b>
<b>Monitor</b>	Panel size: <b>6.2" diagonal measurement</b> View angle (up/down/left/right): <b>50/70/70/70</b> Resolution: <b>800 (H) x 480 (V)</b> Brightness (cd/m <sup>2</sup> ): <b>250</b> Contrast ratio: <b>500:1</b> Pixels: <b>1,152,000</b>
<b>Navigation</b>	<b>iGo Primo</b> <b>USA Map Data (Includes: Puerto Rico and Virgin Islands)</b> <b>Over 11 Million Points of Interest (POI)</b> <b>8GB SD Card w/ Navigation Software</b> <b>Latest Map Guarantee (LMG) Must be Redeemed within 30 Days of Installation</b>
<b>MicroSD Card</b>	For navigation use only. Contains microSD card with navigation software. Do not remove microSD card. Do not delete / modify SD card folder structure.
<b>General</b>	Speaker output impedance: <b>4 ohms</b> Line output voltage: <b>4 volt RMS</b> Line output impedance: <b>200 ohms</b> Chassis dimensions: <b>7" x 7" x 4" (W x D x H)</b>  Design and specifications subject to change without notice.



CEA-2006 Power Standard Specifications  
(reference: 14.4VDC +/- 0.2V, 20Hz~20kHz)

Power Output: 16 Watts RMS x 4 channels at 4 ohms and  $\leq 1\%$  THD+N  
Signal to Noise Ratio: 80dB (reference: 1 watt into 4 ohms)





---

## Limited One Year Warranty

This warranty gives you specific legal rights. You may also have other rights which vary from state to state.

Dual Electronics Corp. warrants this product to the original purchaser to be free from defects in material and workmanship for a period of one year from the date of the original purchase.

Dual Electronics Corp. agrees, at our option, during the warranty period, to repair any defect in material or workmanship or to furnish an equal new, renewed or comparable product (whichever is deemed necessary) in exchange without charges, subject to verification of the defect or malfunction and proof of the date of purchase. Subsequent replacement products are warranted for the balance of the original warranty period.

**Who is covered?** This warranty is extended to the original retail purchaser for products purchased from an authorized Dual dealer and used in the U.S.A.

**What is covered?** This warranty covers all defects in material and workmanship in this product. The following are not covered: software, installation/removal costs, damage resulting from accident, misuse, abuse, neglect, product modification, improper installation, incorrect line voltage, unauthorized repair or failure to follow instructions supplied with the product, or damage occurring during return shipment of the product. Specific license conditions and copyright notices for the software can be found via [www.dualav.com](http://www.dualav.com).

### What to do?

1. Before you call for service, check the troubleshooting guide in your owner's manual. A slight adjustment of any custom controls may save you a service call.
2. If you require service during the warranty period, you must carefully pack the product (preferably in the original package) and ship it by prepaid transportation with a copy of the original receipt from the retailer to an authorized service center.
3. Please describe your problem in writing and include your name, a return UPS shipping address (P.O. Box not acceptable), and a daytime phone number with your shipment.
4. For more information and for the location of the nearest authorized service center please contact us by one of the following methods:
  - Call us toll-free at 1-866-382-5476
  - E-mail us at [cs@dualav.com](mailto:cs@dualav.com)

**Exclusion of Certain Damages:** This warranty is exclusive and in lieu of any and all other warranties, expressed or implied, including without limitation the implied warranties of merchantability and fitness for a particular purpose and any obligation, liability, right, claim or remedy in contract or tort, whether or not arising from the company's negligence, actual or imputed. No person or representative is authorized to assume for the company any other liability in connection with the sale of this product. In no event shall the company be liable for indirect, incidental or consequential damages.



# Troubleshooting

General		
Problem	Cause	Action
Unit will not turn on (no power)	Yellow wire not connected or incorrect voltage Red wire not connected or incorrect voltage	Check connections for proper voltage (11~16VDC)
	Black wire not connected	Check connection to ground
	Fuse blown	Replace fuse(s)
Unit has power (but no sound)	Speaker wires not connected	Check connections at speakers
	One or more speaker wires touching each other or touching chassis ground	Insulate all bare speaker wires from each other and chassis ground
Unit blows fuse(s)	Yellow or red wire touching chassis ground	Check for pinched wire
	Speaker wires touching chassis ground	Check for pinched wire
	Incorrect fuse rating	Use fuses with correct rating
Unit has audio (but no video)	Parking brake safety circuit not connected Parking brake not applied	Check connections at parking brake Apply parking brake as described on page 26
No video display (when in reverse)	Reverse circuit not connected Vehicle is not in reverse	Check connections at reverse lamp Select reverse gear
DVD does not start playback	Physical defect in media Wrong region	Check media for scratches Use discs labeled "Region 1" or "All" only
IR remote does not work	Dead battery	Replace battery
Excessive skipping	Unit is not mounted correctly	Check mounting sleeve
	Physical defect in media	Check media for scratches
Disc Region Incorrect appears on display	Region code error	Use discs labeled "Region 1" or "All" only

**For Your Records**

Please keep your original sales receipt and be prepared to provide this receipt in the event you require service, as your original receipt is considered the best proof of purchase and indicates the date you purchased your Dual product.

Dealer Name \_\_\_\_\_

Dealer Phone \_\_\_\_\_

Purchase Date \_\_\_\_\_

**Register Your Product**

Register your product online at [www.dualav.com](http://www.dualav.com).





Dual Electronics Corp.  
Toll Free: 1-866-382-5476  
Monday-Friday, 9AM-5PM EST

[www.dualav.com](http://www.dualav.com)  
©2017 Dual Electronics Corp. All rights reserved.  
NSA1017-V01  
Printed in China