

MTR14G

INSTALLATION/OWNER'S MANUAL

AM/FM Weatherproof Receiver with Bluetooth and Fixed Face

MP3

USB

AUX

Bluetooth®

Dual®



Preparation

Please read entire manual before installation.

Before You Start

- Disconnect negative battery terminal. Consult a qualified technician for instructions.
- Avoid installing the unit where it would be subject to high temperatures, such as from direct sunlight, or where it would be subject to dust, dirt or excessive vibration.

Getting Started

- Insert the supplied keys into the slots as shown, and slide the unit out of the mounting sleeve.
- Install mounting sleeve into opening, bending tabs to secure.
- Connect wiring harness and antenna. Consult a qualified technician if you are unsure.
- Certain vehicles may require an installation kit and/or wiring harness adapter (sold separately).
- Test for correct operation and slide into mounting sleeve to secure.
- Snap trim ring into place.

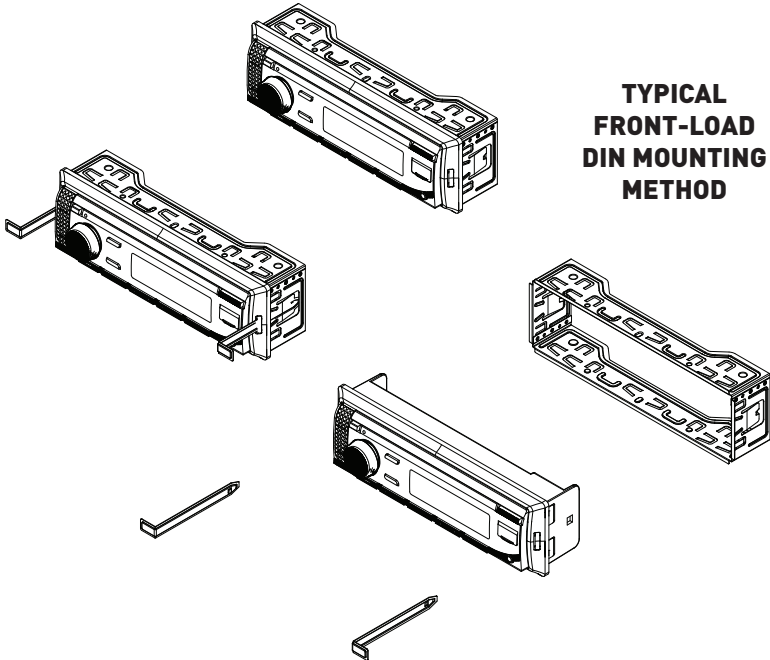

Wiring Diagram

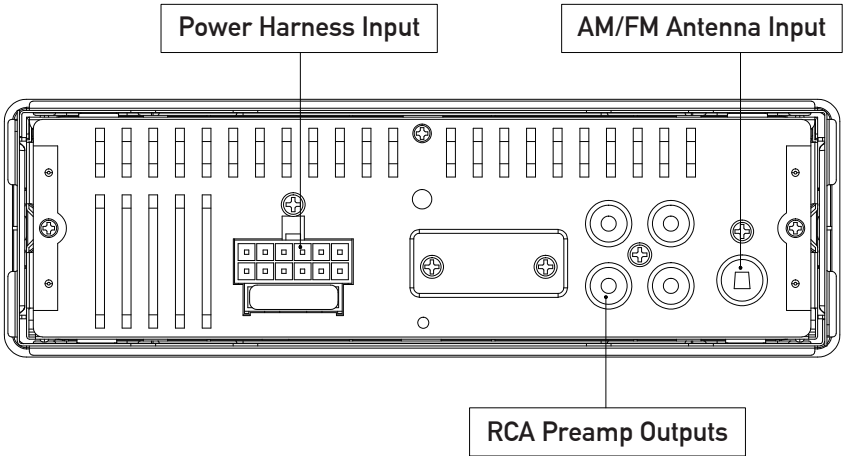

The chart below shows the connection for each wire in the wiring harness.

Color	Connection
Red	12V Ignition / Accessory
Yellow	12V Battery / Memory
Black	Ground
Blue	Power Antenna / Amp Turn-on
White	Left Front (+)
White/Black	Left Front (-)
Gray	Right Front (+)
Gray/Black	Right Front (-)

Tractor plug models	
TRWHKUB	Harness for Kubota and other Tractors
TRWHKTI	Harness for Kioti and other Tractors
TRWHCAT	Harness for Caterpillar and other Tractors
TRWHJDR	Harness for John Deere and other Tractors

FUSE

When replacing the fuse, make sure new fuse is the correct type and amperage. Using an incorrect fuse could damage the radio.
 USE 10A ATC
 REPLACEMENT FUSE ONLY





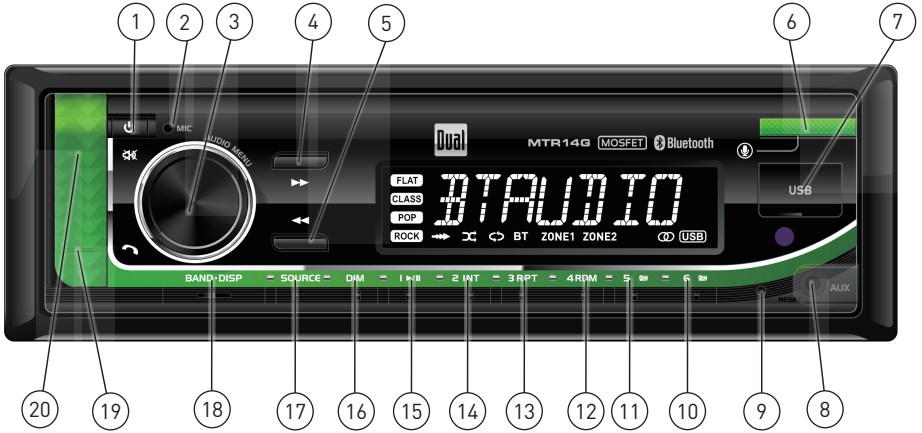

MTR14G INSTALLATION

Control Locations



- | | | |
|---------------------|--------------------------|-------------------------|
| ① Power | ⑧ Auxiliary Input | ⑮ Preset 1 / Play/Pause |
| ② Microphone | ⑨ Reset | ⑯ Dimmer |
| ③ Volume / Audio | ⑩ Preset 6 / Folder Up | ⑰ Source |
| ④ Tune / Track Up | ⑪ Preset 5 / Folder Down | ⑱ Band/Display |
| ⑤ Tune / Track Down | ⑫ Preset 4 / Random | ⑲ Bluetooth Talk |
| ⑥ Voice Assist | ⑬ Preset 3 / Repeat | ⑳ Mute |
| ⑦ USB Port | ⑭ Preset 2 / Intro | |

General Operation

Power On/Off	Press the  button to turn the unit on. Press  again to turn the unit off.
Changing Modes	Press SOURCE to select between Radio, USB, Auxiliary Input and Bluetooth. Sources of operation are shown in the display.
Volume	Adjust volume using the volume knob .
Mute	Press  to silence the audio. Press  again to resume listening at the previously selected volume.
Display	Press DISP to toggle between various displayed information.
Dimmer	Press DIM to select the dimmer level: DIM HI/DIM MED/DIM LOW.
Auxiliary Input	Insert a 3.5mm cable in the unit's front AUX port.
Setting the Clock	<p>With the unit on, press BAND/DISP to display clock time. Press and hold BAND/DISP until the hours begins to flash, then release.</p> <p>Rotate the volume knob left or right to adjust the hours, then press BAND/DISP. When the minutes begins to flash, rotate the volume knob left or right to adjust the minutes.</p> <p>Press BAND/DISP momentarily to save the selected time.</p>
Reset	Press the RESET button to reset the unit back to the factory settings if abnormal operation occurs. The reset button is located on the front panel.
Audio / Menu	<p>Press the volume knob momentarily to select between audio functions.</p> <p>Press and hold the volume knob for more than two seconds to select between the menu functions.</p> <p>Rotate the volume knob left/right to adjust or activate the desired function/audio.</p>
Audio Zone	Press and hold the volume knob to select the menu, ZONE1 and ZONE2. Rotate the volume knob right to adjust ZONE OFF, ZONE1 ON, ZONE2 ON, and ZONE1 and 2 on. (Included IR remote can also control them.)



AM/FM Tuner Operation

Seek Tuning	Press and hold TUNE ◀◀ or TUNE ▶▶ for two seconds to auto seek to the previous or next strong station.
Manual Tuning	Press TUNE ◀◀ or TUNE ▶▶ momentarily to change radio frequency up or down one step at a time. Press and hold TUNE ◀◀ or TUNE ▶▶ for three seconds to advance quickly, then release it to stop on desired station.
Band	Press BAND to select between FM1, FM2, FM3, AM1 and AM2 bands. Up to six presets can be programmed for each band, enabling up to 18 FM stations and 12 AM stations to be stored in memory.
Storing Presets	To store a station, select the desired band and station. Press and hold the desired preset button (1-6) for more than two seconds. When stored, the preset number will appear in the display.
Recalling Presets	Preset stations can be recalled anytime by pressing the corresponding preset button.
Auto Store	Press and hold the volume knob for more than two seconds, then press DISP to 18 FM stations and 12 AM stations automatically.
Preset Scan Stations	Touch PS to recall each preset station that has been stored in memory for each band.

USB Operation

Playing MP3 Files	To play MP3 files, insert a USB device containing MP3 files.
Track Select	Press TUNE ►► to skip to the beginning of the next track. Press TUNE ◀◀ to skip to the beginning of the previous track.
Fast Forward and Reverse	Press and hold TUNE ►► or TUNE ◀◀ to fast forward or reverse a track.
Pause	Press ► / II to temporarily stop USB playback. Press ► / II again to resume playback.
Folder Access	Folders can be found by pressing Folder Up or Folder Down. About one second after the folder name is displayed, the first file under the selected folder will be displayed and playback will begin.
Repeat	Press RPT to toggle between RPT ALL, RPT FLR and RPT ONE. <ul style="list-style-type: none">• RPT ALL - Plays all tracks on USB device.• RPT ONE - Continuously repeats selected track.
Random	Press RDM to play tracks in random order; press again to cancel the RDM function.
Intro	Press INT to play the first 10 seconds of each track; press again to cancel the INT function.



Bluetooth Operation

Preparation

Before using a Bluetooth device, it must be paired and connected. Ensure that Bluetooth is activated on your device before beginning the pairing process.

Pairing a New Device

The head unit broadcasts the pairing signal constantly when no devices are connected. Complete the pairing sequence from your Bluetooth device. Refer to the owner's manual for your device for more details.

The device name is "Dual Media Player".
The Bluetooth passcode is "1234".

Note: If passcode "1234" does not pair your device to the receiver, use passcode "0000".

Note: The head unit can be in any mode of operation when pairing is performed.

Streaming Audio Troubleshooting

The head unit supports A2DP wireless streaming audio from a Bluetooth mobile device directly to your head unit.

The following functions can be used to control the music:

- Press ►► to skip to the next available audio track.
- Press ◀◀ to skip to the previous audio track.
- Press ►/ || to toggle between play and pause during playback.



Voice Activation

Your receiver is designed with an easy access voice activation button to use Siri® or the Google Assistant™ via your car's Bluetooth. Interact with your smartphone assistant while you drive with only the push of a button!

Bluetooth should be paired between your smartphone and the receiver. Press the voice activation button, and the receiver will switch into Bluetooth mode, This will activate Siri® or Google Assistant™ on your smartphone. You will need to manually switch back to the previous or desired mode once this operation is terminated.



Specifications

FM Tuner

Tuning range: **87.5MHz-107.9MHz**
Usable sensitivity: **8.5dBf**
50dB quieting sensitivity: **10dBf**
Stereo separation @ 1kHz: **>30dB**
Frequency response: **30Hz-13kHz**

AM Tuner

Tuning range: **530kHz-1710kHz**
Usable sensitivity: **<42dBu**
Frequency response: **30Hz-2.2kHz**

General

Speaker output impedance: **4~8 ohms**
Line output voltage: **1.2 Volts RMS**
Dimensions: **7" x 2" x 2" (178 x 50 x 50 mm)**

Design and specifications subject to change without notice.



CEA-2006 Power Standard Specifications
(reference: 14.4VDC +/- 0.2V, 20Hz~20kHz)

Power Output: 16 Watts RMS X 2 channels at 4 ohms and \leq 1% THD+N

Signal to Noise Ratio: 75dBA (reference: 1 watt into 4 ohms)

Troubleshooting

Problem	Cause	Action
Unit will not turn on (no power)	Yellow wire not connected or incorrect voltage Red wire not connected or incorrect voltage	Check connections for proper voltage (11~16VDC)
	Black wire not connected	Check connection to ground
	Fuse blown	Replace fuse
Unit has power (but no sound)	Speaker wires not connected	Check connections at speakers
	One or more speaker wires touching each other or touching chassis ground	Insulate all bare speaker wires from each other and chassis ground
Unit blows fuses	Yellow or red wire touching chassis ground	Check for pinched wire
	Speaker wires touching chassis ground	Check for pinched wire
	Incorrect fuse rating	Use fuse with correct rating
NO FILE appears on display	No playable MP3 files found on the device	Check the device for valid MP3 files
NO SUPPORT appears on display	An invalid ID3 tag version is present	Version 1.0 to 2.0 ID3 tags are supported.



Limited One Year* Warranty

This warranty gives you specific legal rights. You may also have other rights which vary from state to state.

Dual Electronics Corp. Inc warrants this product to the original purchaser to be free from defects in material and workmanship for a period of one year from the date of the original purchase.

Dual Electronics Corp. Inc agrees, at our option, during the warranty period, to repair any defect in material or workmanship or to furnish an equal new, renewed, or comparable product (whichever is deemed necessary) in exchange without charges, subject to verification of the defect or malfunction and proof of the date of purchase. Subsequent replacement products are warranted for the balance of the original warranty period.

What is covered?

This warranty covers all defects in the material and workmanship in this product. The following are not covered: software, installation/removal costs, damage resulting from accident, misuse, abuse, neglect, product modification, improper installation, incorrect line voltage, unauthorized repair, or failure to follow instructions supplied with the product, or damage occurring during return shipment of the product. Specific license conditions and copyright notices for the software can be found via www.dualav.com.

Warranty Coverage

* Limited 1-year warranty. (Proof of purchase required)

- Extended Coverage: Extend your warranty from 1 year to 2 years when you register online at www.dualav.com. Registration must be completed within 60 days of the original purchase date to qualify for this extension.

What to do?

1. Before you call for service, check the troubleshooting guide in your owner's manual. A slight adjustment of any custom controls may save you a service call.
2. If you require service during the warranty period, you must carefully pack the product (preferably in the original package) and ship it by prepaid transportation with a copy of the original receipt from the retailer to an authorized service center.
3. Please describe your problem in writing and include your name, a return UPS shipping address (P.O. Box not acceptable), and a daytime phone number with your shipment.
4. For more information and for the location of the nearest authorized service center please contact us by one of the following methods
 - a. Call us toll-free at (866) 382-5476 (Monday-Friday, 9:00 am to 5:00 pm, EST)
 - b. E-mail us at cs@dualav.com

Exclusion of Certain Damages:

This warranty is exclusive and in lieu of any and all other warranties, expressed or implied, including without limitation the implied warranties of merchantability and fitness for a particular purpose and any obligation, liability, right, claim or remedy in contract or tort, whether or not arising from the company's negligence, actual or imputed. No person or representative is authorized to assume for the company any other liability in connection with the sale of this product. In no event shall the company be liable for indirect, incidental, or consequential damages.



FCC Compliance

This device complies with Part 15 of the FCC Rules. Operation is subject to the following two conditions:

- (1) this device may not cause harmful interference, and
- (2) this device must accept any interference received, including interference that may cause undesired operation.

Warning: Changes or modifications to this unit not expressly approved by the party responsible for compliance could void the user's authority to operate the equipment.

Note: This equipment has been tested and found to comply with the limits for a Class B digital device, pursuant to Part 15 of the FCC Rules. These limits are designed to provide reasonable protection against harmful interference in a residential installation. This equipment generates, uses and can radiate radio frequency energy and, if not installed and used in accordance with the instructions, may cause harmful interference to radio communications. However, there is no guarantee that interference will not occur in a particular installation. If this equipment does cause harmful interference to radio or television reception, which can be determined by turning the equipment off and on, the user is encouraged to try to correct the interference by one or more of the following measures:

- Reorient or relocate the receiving antenna.
- Increase the separation between the equipment and receiver.
- Connect the equipment into an outlet on a circuit different from that to which the receiver is connected.
- Consult the dealer or an experienced radio/TV technician for help.



Dual Electronics Corp.
Toll Free: 1-866-382-5476

www.dualav.com

©2024 Dual Electronics Corp. All rights reserved.

The Bluetooth® word mark and logos are owned by the Bluetooth SIG, Inc

Other trademarks and trade names are those of their respective owners.

NSC0124-V01