



# DCPA723W-M

## INSTALLATION/OWNER'S MANUAL

Media Receiver with Android Auto™ and Apple CarPlay®  
featuring a 7" digital TFT Display



**USB**

**MP3**



## Safety Notes

**This is a safety feature to prevent driver distraction. In-dash video functions will only operate when vehicle is in Park and the parking brake is engaged. It is illegal in most jurisdictions for the driver to view video while the vehicle is in motion.**

The SAFETY NOTICE is reminder to drive responsibly and safely while using your mobile phone device, or any apps that are compatible with this unit.

It is highly recommended that your Dual unit is installed by a professional installer or an authorized dealer. This product is only for use in vehicles with 12VDC negative ground only.

### To prevent damage or injury:

- Make sure to ground the unit securely to the vehicle chassis ground.
- Do not remove the top or bottom covers of the unit.
- Do not install the unit in a spot exposed to direct sunlight, excessive heat or the possibility of water splashing.
- Do not subject the unit to excessive shock.
- When replacing a fuse, only use a new one with the correct rating. Using a fuse with the wrong rating may cause the unit to malfunction.
- To prevent short circuits when replacing a fuse, disconnect the wiring harness first.
- Use only the provided hardware and wire harness.
- If you experience problems during installation, consult your nearest Dual dealer.
- If the unit malfunctions, reset the unit as described. If the problem still persists, consult your nearest Dual dealer or call technical assistance @ 1-866-382-5476.
- To clean the monitor, wipe only with a dry silicone cloth or other soft cloth. Do not use a stiff cloth or solvents such as paint thinner and alcohol, as these can scratch the surface of the panel and/or remove the printing.
- When the temperature of the unit falls (as in winter), the liquid crystal inside the screen will become darker than usual. Normal brightness will return after the unit is in use for a while.
- When extending the ignition, battery or ground wiring, make sure to use automotive-grade wiring with an a minimum AWG 16 or more to prevent voltage drops.
- Do not touch the liquid crystal fluid if the LCD is damaged or broken. The liquid crystal fluid may be hazardous to your health or fatal. If the liquid crystal fluid from the LCD contacts your body or clothing, wash it off with soap immediately.

### Copyright Notes

This product incorporates copyright protection technology that is protected by method claims of certain U.S. patents and other intellectual property rights owned by Macrovision Corporation and other rights owners. Use of this copyright protection technology must be authorized by Macrovision Corporation, and is intended for home and other limited viewing uses only unless otherwise authorized by Macrovision Corporation. Reverse engineering or disassembly is prohibited.

The Bluetooth® word mark and logos are owned by the Bluetooth SIG, Inc.

Use of the Apple CarPlay logo means that a vehicle user interface meets Apple performance standards. Apple is not responsible for the operation of this vehicle or its compliance with safety and regulatory standards. Please note that use of this product with iPhone, iPod or iPad may affect wireless performance. Apple CarPlay is a trademark of Apple Inc. "Made for iPod" and "Made for iPhone" mean that an electronic accessory has been designed to connect specifically to iPod or iPhone, respectively, and has been certified by the developer to meet Apple performance standards. iPhone and iPod are trademarks of Apple, Inc., registered in the U.S. and other countries.

Availability of Android Auto™ may vary depending upon your country and phone model. Please visit [android.com/auto](http://android.com/auto) for more information. Android, Android Auto, Google and other marks are trademarks of Google Inc.

SiriusXM and all related marks and logos are trademarks of SiriusXM Radio, Inc. All rights reserved.

Other trademarks and trade names are those of their respective owners.

# Table of Contents

Page

Warning Statement .....	3
FCC Compliance .....	4
Preparation/Mounting .....	5
Wiring Diagram .....	6
Control Locations .....	7
General Operation .....	8-9
Screen Operation .....	10-11
Audio Operation .....	12
AM/FM Tuner Operation .....	13
USB Operation .....	14
Media Compatibility .....	15
Bluetooth Operation .....	16-17
Driver Orientation Settings .....	18
Apple CarPlay .....	19-20
Android Auto .....	21-22
Auxiliary Inputs /Front & Rear Camera Operation .....	23
SWC Input Operation .....	24
SiriusXM <sup>®</sup> Satellite Radio Operation .....	25-30
iDataLink Operation .....	31-35
Metra operation .....	36-38
Trouble Shooting .....	39
Specifications .....	40
Warranty .....	41



## ⚠ WARNING ⚠

Upon installation of this monitor/media player ("unit") into a vehicle, the driver of the vehicle must not operate this unit by watching videos or playing video games while driving. Failure to follow this instruction could lead to driver distraction which could result in serious injury or death to the vehicle's occupants or persons outside the vehicle and/or property damage.

Several states prohibit the installation of monitors/media players if the screen is visible from the driver's seat. If you reside in a jurisdiction which has enacted such a law, this unit must not be installed so that the screen is visible from the driver's seat. When installing this unit in the front console/dashboard, the unit must be positioned so that it is facing the front passenger seat only. Failure to follow this instruction could lead to driver distraction which could result in serious injury or death to the vehicle's occupants or persons outside the vehicle and/or property damage.

This unit is designed so that it may be operated only when the vehicle is in "Park" and the parking brake is fully engaged. To this end, this unit includes a parking brake lock-out feature which prohibits the unit from operating if the vehicle is not in "Park" and/or the parking brake is not fully engaged. When installing this unit, the installer must connect the parking brake detect wire to the parking brake mechanism in order to make the parking brake lock-out feature operable. DO NOT simply ground the parking brake detect wire to a metal portion of the vehicle. Failure to properly install the parking brake lock-out feature could lead to driver distraction which could result in serious injury or death to the driver's occupants or persons outside the vehicle and/or property damage.

Once the parking brake lock-out feature is installed, the owner/user must not attempt to disrupt/neutralize the parking brake lock-out feature by (a) partially engaging the parking brake and/or (b) purchasing/using any device or unit designed to send necessary brake signals to the unit. Failure to follow these instructions could lead to driver distraction which could result in serious injury or death to the driver's occupants or persons outside the vehicle and/or property damage.

When operating this unit, keep the unit's volume level low enough so that the vehicle's occupants can hear traffic-related sounds such as police and emergency vehicles. Failure to follow this instruction could lead to driver distraction which could result in serious injury or death to the vehicle's occupants or persons outside the vehicle and/or property damage.

---

## FCC Compliance

This device complies with Part 15 of the FCC Rules. Operation is subject to the following two conditions:

- (1) this device may not cause harmful interference, and
- (2) this device must accept any interference received, including interference that may cause undesired operation.

**Warning:** Changes or modifications to this unit not expressly approved by the party responsible for compliance could void the user's authority to operate the equipment.

This equipment complies with FCC radiation exposure limits set forth for an uncontrolled environment. This equipment should be installed and operated with a minimum distance of 20cm between the radiator & your body. This transmitter must not be co-located or operating in conjunction with any other antenna or transmitter.

**Note:** This equipment has been tested and found to comply with the limits for a Class B digital device, pursuant to Part 15 of the FCC Rules. These limits are designed to provide reasonable protection against harmful interference in a residential installation. This equipment generates, uses and can radiate radio frequency energy and, if not installed and used in accordance with the instructions, may cause harmful interference to radio communications. However, there is no guarantee that interference will not occur in a particular installation. If this equipment does cause harmful interference to radio or television reception, which can be determined by turning the equipment off and on, the user is encouraged to try to correct the interference by one or more of the following measures:

- Reorient or relocate the receiving antenna.
- Increase the separation between the equipment and receiver.
- Connect the equipment into an outlet on a circuit different from that to which the receiver is connected.
- Consult the dealer or an experienced radio/TV technician for help.

## Preparation

### Before You Start

Disconnect negative battery terminal. Consult a qualified technician for instructions.

Avoid installing the unit where it would be subject to high temperatures, such as from direct sunlight, or where it would be subject to dust, dirt or excessive vibration.

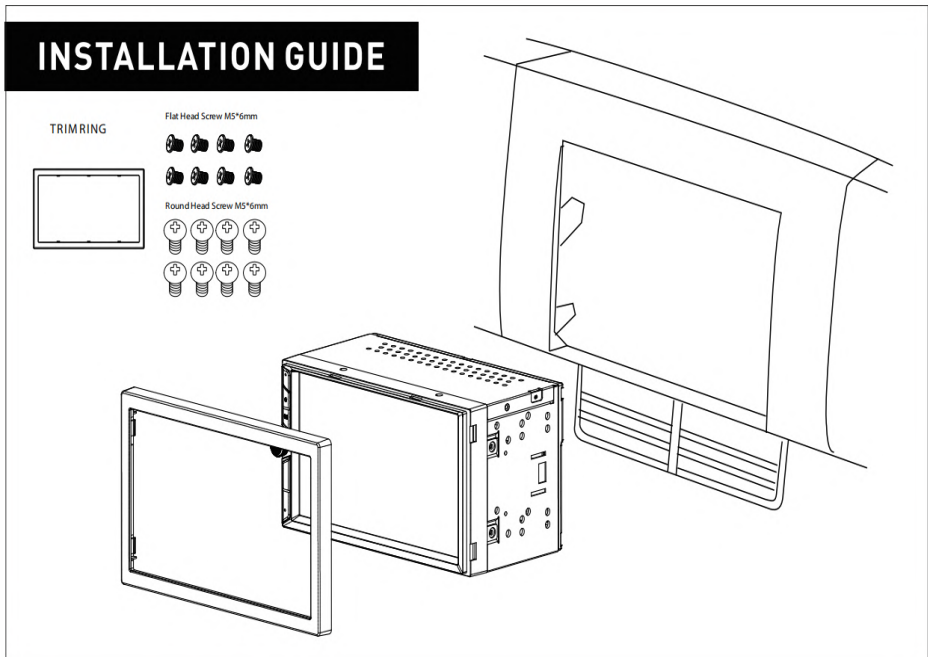

## Wiring Diagram-Inputs/Outputs

Note: Works for Apple CarPlay and Android Auto only.

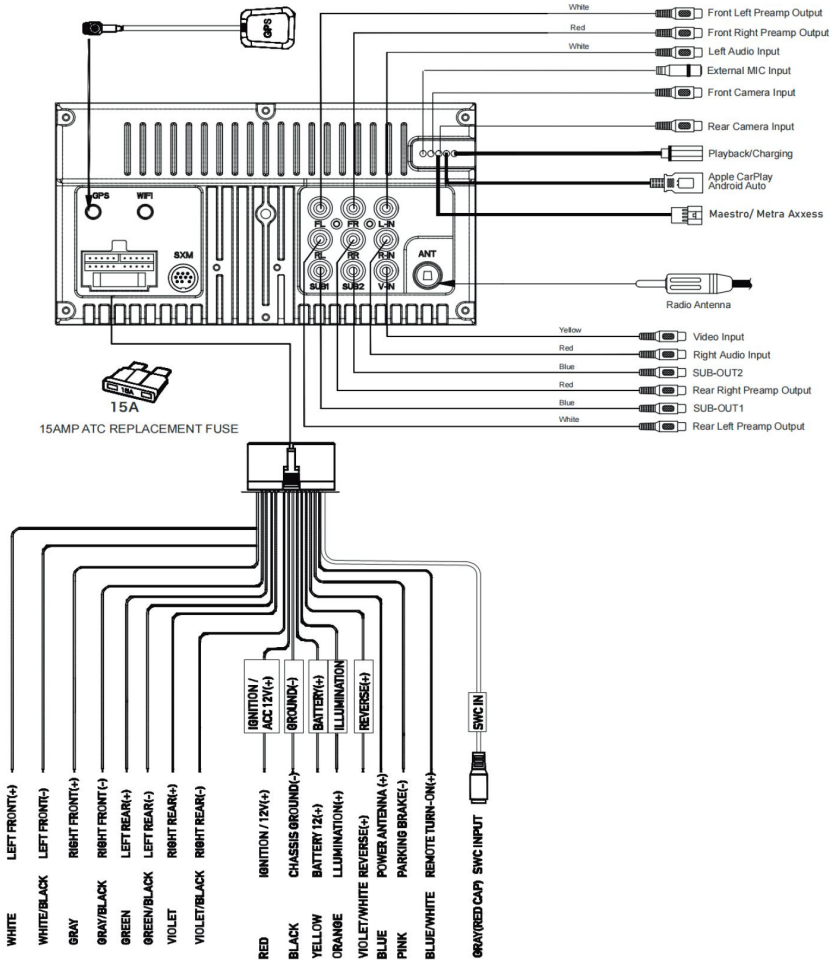

**Note:**

When replacing a fuse, make sure to use the correct type and amperage. Using an incorrect fuse could cause damage. The unit uses (1) 15 amp ATC mini style fuse located on the power connector.

## Control Locations



The radio display features the following functions and displays:

- ① Power
- ② Mute
- ③ Volume/Voice Activation
- ④ Reset

## General Operation

- Power On/Off** Momentarily press **⏻** to turn the unit on. Press and hold to turn the unit off.
- Volume** Rotate the **volume knob** to increase or decrease the volume level.
- Mute** Momentarily press **MUTE** to silence the audio. Momentarily press **MUTE** again to return to the previously selected volume. Rotating the **volume knob** while the volume is muted will also cancel the mute function.
- Mode** Press **SOURCE** to step through the following modes of operation: AM/FM/Bluetooth Phone/SiriusXM/Apple Carplay/Android Auto/Car Info/Bluetooth Audio/USB/Camera/EQ/AV In/Settings .
- Note:** Modes of operation can also be accessed by selecting the corresponding icon from the main menu.
- Main Menu** Press the **🏠** icon at the top left corner of the screen to display the OSD main menu. Press the AM/FM/Bluetooth Phone/SiriusXM/ Apple Carplay/Android Auto/Car Info/Bluetooth Audio/USB/ Camera/EQ/AV In/Settings to select the desired source.

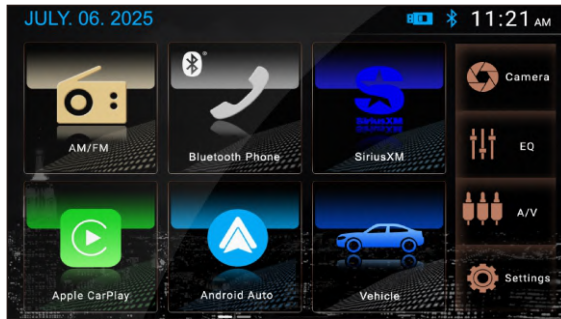

- A/V In** Connect external devices to the rear RCA Type A/V Input.
- USB** Connect a USB flash drive to the rear USB Input.
- Reset** To resolve abnormal operation or if the unit is inoperable, press the **RESET** button located on the front panel as shown in the Control Locations section. The unit will reset the main processor to the default settings.
- Note:** Use the tip of a pen to access the reset button and restore the factory default software settings.

## General Operation

From the Main Menuscreen, select Setup to access the Settings menu and select from eight categories represented by the icons on the left of the screen: General, Audio, Display, Wifi, Bluetooth, Camera, Region and Version. Select the category, and adjust any of the available options using the touch screen.



### General:

- **Language:** Select between English and Spanish.
- **Time Zone:** Select desired time zone.
- **Date & Time:** Adjust the day, month, year, hour, minute and format.
- **Daylight Savings Time:** Turn On or Off.
- **Beep Tone:** Turn On or Off.
- **Power Off Delay:** Select 1 second, 2 seconds, 3 seconds or Off.
- **Factory Default:** Reset the unit to factory default settings.
- **Right Hand Drive:** Turn On or Off. When the item is off, it is left hand drive mode, and when the item is On, it is right hand drive mode. Default setting is Off (left hand drive mode).
- **Maestro:** This product is compatible with both Maestro and Metra CAN tools. When users connect the Maestro tool to the unit, they can select "Maestro" in the settings interface.
- **Metra:** When users connect the Metra tool to the unit, they can select "Metra" on the settings interface.
- **OEM source:** Maestro can be connected to SXM, USB, and Bluetooth externally. When the OEM source is turned on, the product reads SXM, USB, and Bluetooth from Maestro. When the OEM source is turned off, the product reads the SXM, USB, and Bluetooth from the unit.

### Audio:

- **Balance/Fader** - Select to adjust balance/fader settings.
- **Subwoofer** - Turn the Subwoofer Control On/Off.
- **Subwoofer Frequency** - Select subwoofer frequency.
- **Subwoofer Level** - Select subwoofer 0-14 (7 is default).
- **EQ** - Select to adjust EQ settings.
- **Loudness** - Select to turn Loudness feature On or Off.
- **Default Volume** - Select adjust default volume settings.
- **Source Level** - Select to adjust source level settings.

### Display:

- **Illumination Control** - Select to turn Illumination Control On or Off.
- **Gray Level & Brightness** - Adjust Gray Level & Brightness settings for Day and Night.
- **LED** - Select a color for the LED button lights.
- **LED Animation** - Select to turn LED Animation On or Off.
- **Wallpaper** - Select from three wallpaper options.

**WiFi:** Turn WiFi On/Off, Reset Password or view Device List.

**Bluetooth:** Turn Bluetooth, Auto Connect and Auto Answer On/Off, view Device Name and clear Phone Book Names and Numbers.

**Camera:** Turn Front and Rear Camera On/Off, reverse Camera Views, turn Parking Assistance On/Off, adjust Parking Assistance settings and adjust the Rear View Delay.

**Radio:** Adjust the Region, and turn TA and AF On/Off.

**Version:** View version information.

Factory Default-Reset Bluetooth Settings or Reboot System. (Including SiriusXM data reset)

## Screen Operation

Press the Monitor icon in the Settings menu to access the Brightness, Contrast, Button Illumination Colors and Wallpaper Settings.



On this interface, you can control the gray level/brightness of screen during the day/night.

- Gray Level Day: to adjust the gray level of screen during the day. There are a total of 20 levels (from level 1 to level 20, the gray level gradually increases).
- Gray Level Night: to adjust the gray level of screen at night. There are a total of 20 levels (from level 1 to level 20, the gray level gradually increases).
- Day Brightness: to adjust the brightness of screen during the day. There are a total of 10 levels (from level 1 to level 10, the brightness gradually increases).
- Night Brightness: to adjust the brightness of screen at night. There are a total of 10 levels (from level 1 to level 10, the brightness gradually increases).

## Screen Operation

Press the Monitor icon in the Settings menu to access the Brightness, Contrast, Button Illumination Colors and Wallpaper Settings.



On this interface, you can control color of the button lights.

- Button Light Color: a total of 6 colors (red, yellow, green, blue, purple, white). When you turn off "LED Animation", click on the color icon to manually select which color the button light displays.
- LED Animation: there are a total of 6 colors for the button lights. Turn on the "LED Animation", the color will automatically cycle through these 6 colors.

## Audio Operation

### Audio Adjustment Menus

Select from the below 3 icons in the Settings menu to select between Balance, Fader and Time Alignment Settings, EQ Presets and 10-Band EQ Settings or Surround Settings.

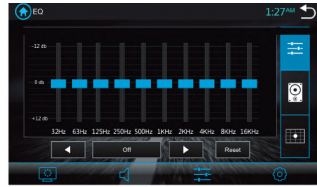
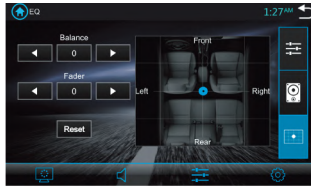

## On Screen Controls



①

②

③

④

- ① Dimmer
- ② Mute
- ③ Audio Settings
- ④ Settings

## AM/FM Tuner Operation

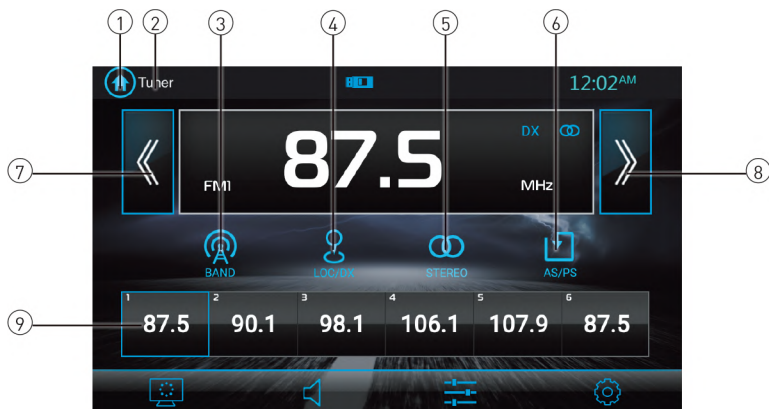

### Radio Operation

From the main menu, touch Radio Icon to select AM/FM tuner mode.

#### Main Menu ①

Press icon to return to Main Menu screen.

#### Current Mode Indicator ②

Display status of various tuning functions including Auto.

#### Band ③

Press to step through three FM and two AM bands.

#### Local / Distance ④

Press to toggle between local or distance tuning.

#### Stereo / Mono ⑤

Press to toggle between stereo and mono operation.

#### AS/PS ⑥

Preset Scan: Press AS/PS to scan through all tunable presets in the current band and play them for 3 seconds each.

Auto Store: Press and hold AS/PS to automatically search and store the six strongest stations in the current band. A total of 18 FM and 12 AM stations can be stored.

#### Seek Tune Down ⑦

Press to automatically tune to a lower frequency.

#### Seek Tune Up ⑧







Press to automatically tune to a higher frequency.

#### Preset Stations ⑨

To store a station as a preset in the current band, tune to the desired station, then press and hold the desired preset number to store. Press any preset button to recall and begin playback of that station. (Hold this button down for a few seconds and it will switch between AS and PS)

## USB Operation



<b>USB</b>	From the main menu, touch the USB icon on the main screen.
<b>Main Menu</b> ①	Press  icon to return to Main Menu screen.
<b>Current Mode Indicator</b> ②	Displays source currently playing.
<b>File Number</b> ③	Displays the current file number.
<b>Repeat</b> ④	Press  to repeat current track and adjust to repeat all tracks in the current folder. Press again to exit repeat mode.
<b>Random</b> ⑤	Press  icon to shuffle all tracks in the current folder and again to shuffle all tracks. Press again to exit random mode.
<b>Track Down</b> ⑥	Press  icon to return to the beginning of the current track.
<b>Play / Pause</b> ⑦	Press  icon to pause or resume playback.
<b>Track Up</b> ⑧	Press  icon to skip ahead to the next song
<b>Folder</b> ⑨	Press to access and navigate a list of all files and folders on the device.
<b>ID3 Tag Display Area</b> ⑩	Press to see the ID3 information of current song.
<b>Album Art</b> ⑪	Press to see the album art information of current song.



## Media Compatibility

<b>Media Compatibility</b>	<p><b>The following types of files are not compatible:</b></p> <ul style="list-style-type: none"><li>• MP3 PRO format, MP3 playlists</li><li>• RMP format</li><li>• AAC, protected AAC, M4A format</li></ul>
<b>Playback Order</b>	<p>MP3 playback sequence begins in the root folder of the USB device. Any empty folders or folders that do not include MP3 files are skipped.</p>
<b>Compatible Recording Formats</b>	<p>ISO9660 standards:</p> <ul style="list-style-type: none"><li>• Maximum nested folder depth is 8 (including the root folder).</li><li>• Valid characters for folder/file names are letters A-Z (all caps), numbers 0-9, and "_" (underscore). Some characters may not be displayed correctly, depending on the character type.</li><li>• This device can play back files in Joliet and other standards that conform to ISO9660. MP3 written in the formats other than the above may not play and/or their file names or folder names may not be displayed properly.</li></ul>
<b>Notes</b>	<p>Some files may not play or be displayed correctly, depending on sampling rates and bit rates.</p> <p>For best results, use the following settings when ripping MP3 files:</p> <ul style="list-style-type: none"><li>128kbps or higher constant bit rate</li><li>44.1 kHz or higher sampling frequency</li></ul>

## Bluetooth Operation



### Before using Bluetooth

Before you can use a Bluetooth device to make hands-free calls or stream audio, it must be authenticated. This is also referred to as "pairing" a device.

### Pairing a New Device

The unit broadcasts the pairing signal constantly when no devices are currently connected. Complete the pairing sequence from your Bluetooth device. Refer to the owner's manual for your device for more details. The device name is "DCPA723W-M". The unit can be in any mode of operation when pairing is performed. On certain phones, pairing may need to be done more than once.

### Connect

The head unit will automatically connect to the last connected device when the connect feature is set to Auto connect On. If the connect feature is set to Auto Connect Off, the head unit will not automatically connect to any device.

### Bluetooth Phone

From the main menu, touch the Bluetooth on the screen. Bluetooth icon will appear anytime a Bluetooth device is connected.

### Main Menu ①

Press  icon to return to Main Menu screen.

### Current Mode Indicator ②

Displays current mode of operation.

### Bluetooth Status Indicator ③

When Bluetooth is On and a Bluetooth device is being paired, the indicator will flash. When Bluetooth is On and a phone is connected to the unit, the indicator will illuminate steady.

### Phone Keypad ④

Use the keypad to dial a phone number.

### Call ⑤

Press to connect a call after dialing a phone number.

## Bluetooth Operation

- End Call** ⑥ Press to end a call in progress or reject an incoming call.
- Devices** ⑦ Press to show the pairing device list. To connect to a previously connected device. Press the current device name. Any previously connected devices that are in rang will be listed by their device name. Press the desired device name to disconnect from the current device and connect to the new device.
- Calling Screen Mode** ⑧ Press to access the calling screen during a call.
- Last Number** ⑨ Press to call the last number dialed.
- Disconnect Bluetooth** ⑩ Press to disconnect the current BT connection.



⑪      ⑫      ⑬

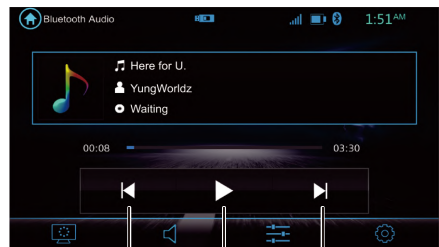

⑭      ⑮      ⑯

- Phone keypad** ⑪ Provides an alternate method of accessing the phone keypad during a call.
- Audio Transfer Button** ⑫ Press to transfer audio between the unit and mobile phone.
- Microphone** ⑬ Press to turn the Microphone voice On or Off.
- Track Down** ⑭ Press <img alt="Track Down icon" data-bbox="350 730 365 745"/> icon to return to the beginning of the current track.
- Play / Pause** ⑮ Press <img alt="Play/Pause icon" data-bbox="350 760 365 775"/> icon to pause or resume playback.
- Track Up** ⑯ Touch <img alt="Track Up icon" data-bbox="350 790 365 805"/> icon to skip ahead to the next song.

## Driving Orientation Settings

To enhance the driving experience, the DCPA723W-M allows the user to configure Apple CarPlay for either Left Hand Drive (LHD) or Right Hand Drive (RHD) vehicles.

To select desired configuration, select either LHD or RHD from the Settings menu.

**Note:** If you change the setting for Right Hand Drive mode or Left Hand Drive mode while the phone is connected to the receiver, disconnect the phone from the receiver and re-connect it again.



The resulting configuration options are shown below:



Apple CarPlay - Left Hand Drive

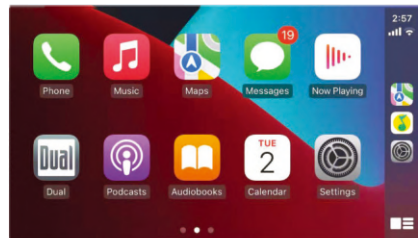

Apple CarPlay - Right Hand Drive

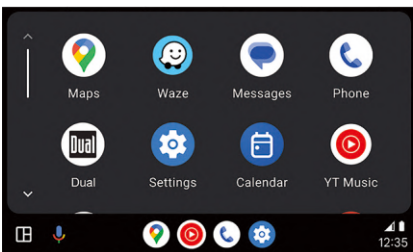

Android Auto - Left Hand Drive

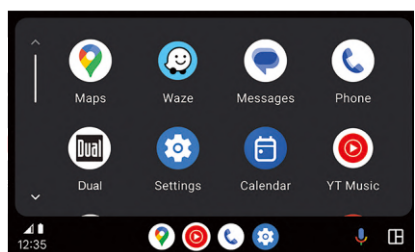

Android Auto - Right Hand Drive



## Apple CarPlay® Operation

Apple CarPlay is a smart interface for iPhone, allowing you to voice-control (via Siri) music, navigation, phone and messaging apps - significantly reducing driver distraction.



Phone - Use Siri to make calls, return missed calls, listen to voicemail messages, and view the caller ID on the receiver's screen.



Messages - Ask Siri to send, read, and reply to text messages. This hands free operation minimizes distraction and allows you to keep hands on the wheel and eyes on the road.



Music - Access music by artist, song, playlist, and more through the receiver's touchscreen or via Siri. The receiver will mirror the iPhone screen with artist and track information.



Maps - Use Siri to request turn-by-turn directions – search by address or points of interest. Apple Maps will be mirrored on the screen, including traffic information and estimated time to destination.

## Compatible Devices

### Made for iPhone models:

For details about compatibility of iPhone models, refer to the following website.

<https://www.apple.com/ios/carplay>

## Starting Apple CarPlay

### Wireless CarPlay Connection Description.

1. Enter the main UI and click BT Phone to enter the Bluetooth interface;
2. Click Refresh to search nearby Bluetooth, click Pair to match Bluetooth;
3. Open the iPhone WLAN to connect to the car, after the connection is successful, the Apple CarPlay icon in the device list will appear, and the Apple CarPlay connection is successful;
4. Enter the Apple CarPlay interface, click the functions of Phone/ Music/Map/Information/etc.

**Note:** For safety reasons, Apple CarPlay features are limited while driving and will vary with each Apple CarPlay-enabled app. Available functions are determined by each individual app provider. For more information, visit [www.apple.com/ios/carplay](http://www.apple.com/ios/carplay).

**Note:** Certain iPhone functions may be illegal while driving in your location. Be sure to familiarize yourself with local and state laws regarding mobile devices. When in doubt, stop and park your vehicle before using any devices.

## Apple CarPlay® Operation

When the Apple CarPlay menu is displayed, the home button in the lower left corner work just like the home button on your iPhone.

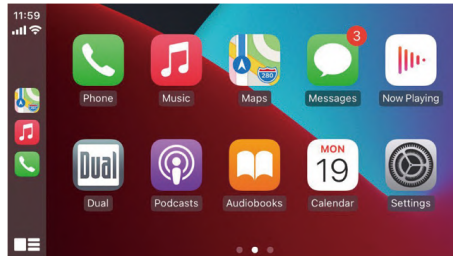

- Ⓞ Press and hold it to summon Siri and begin your voice commands.
- Ⓞ At any time during Apple CarPlay operation, you can press this button momentarily to return to the main Apple CarPlay menu screen.



Press any Application button on the main Apple CarPlay menu to access that operation directly. The toolbar on the left side of the screen displays the time, signal strength and shortcuts to the most popular applications - Phone, Music and Navigation - so they can be accessed quickly and easily without returning to the main menu.

## Controlling Apple CarPlay

The following basic controls will operate many standard Apple CarPlay features.

-  Touch - Briefly press the desired option.
-  Swipe - Briefly swipe in the desired direction.
-  Drag - Press, hold and drag to the desired location.

## Exiting Apple CarPlay

Disconnecting your iPhone will automatically exit Apple CarPlay mode. To exit Apple CarPlay mode while your phone is still connected, press the Power/Volume knob momentarily, and the unit's main menu will be displayed.



## Android Auto™ Operation

Android Auto brings the most useful apps to your phone screen or your compatible car display, in a format that makes it easy for you to keep your main focus on driving. You can control things like navigation and maps, calls and text messages, and music.

### Google Assistant

With your Google Assistant on Android Auto, you can keep your eyes on the road and your hands on the wheel while using your voice to help you with your day. Simply say, "Ok Google," or in compatible cars, long press the voice control button on your steering wheel.

### Navigation

Get real-time traffic alerts to avoid hazards, speed traps, and find the fastest route. Or take a break and find a bite along the way.

### Calls & Messages

Your Google Assistant lets you stay connected while you're driving. Your Assistant can help you call phone numbers from your contacts, chat with your favorite apps, read your messages aloud and text back, keeping your hands on the wheel.

## Compatible Devices

For details about compatibility of Android models, refer to the following website.

<https://support.google.com/androidauto>

Compatible Android phone and compatible active data plan required.

### Warning:

Certain uses of the smartphone may not be legal while driving in your jurisdiction, so you must be aware of and obey any such restrictions. If in doubt as to a particular function, only perform it while the car is parked. No feature should be used unless it is safe to do so under the driving conditions you are experiencing.

## Starting Android Auto

### Wireless Android Auto Connection Description.

1. Enter the main UI and click BT Phone to enter the Bluetooth interface;
2. Click Refresh to search nearby Bluetooth. You'd better turn on your Phone's WLAN before you connect to Bluetooth, otherwise the connection will fail;
3. Click Pair to match Bluetooth, then there will be a notification to select settings and select your mobile Phone, and the Android Auto connection is successful;
4. Enter the Android Auto interface, click the functions of Phone/ Music/Map/Information/etc.

**Note:** When the device for Android Auto is connected to this unit, the device is also connected via Bluetooth at the same time. If five devices are already paired, the message confirming whether to delete the registered device is displayed. If you want to delete the device, touch [Agree]. If you want to delete other device, touch [BT Settings] and delete the devices manually.

**Note:** If Android Auto is turned on during a call on a cellular phone other than the Android Auto compatible device, the Bluetooth connection will switch to the Android Auto compatible device after the call.

# Android Auto™ Operation

## Using Android Auto

The Android Auto home screen displays personalized information, like time to your destination, reminders, recent calls incoming messages, the song you're listening to, and Google Now cards.

When the Android Auto menu is displayed, you can say "OK Google" or select the microphone in the upper right corner to talk to Google.

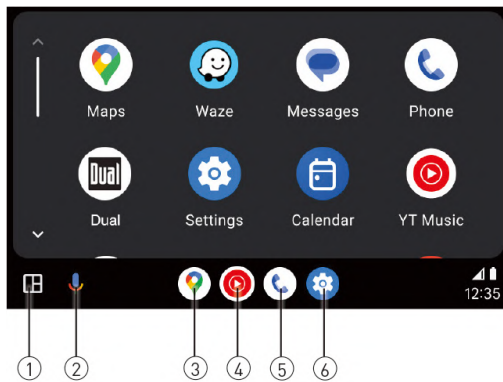

- ① Recent Apps
- ② Google Assistant
- ③ Google Maps
- ④ YouTube
- ⑤ Phone
- ⑥ Settings

## Exiting Android Auto

To exit Android Auto, press the Exit button. Disconnecting your Android phone will automatically exit Android Auto mode.

## Rear RCA Input

**A/V IN** | Connect an optional audio/video source into the RCA (rear) input. Adjust volume on the external audio source as needed (if connected to the headphone output of the device)

## Front and Rear Camera Operation - (Optional)

**Using the Cameras** | Connect an optional camera to the front or rear Camera Input. Refer to the wiring diagram for details.

**Auto Selection** | The unit will automatically select camera mode when connected to the reverse lamp circuitry.

Touch the CAMERA icon on the Main Menu (when enabled) to select camera mode. Touch the top left area of the screen to return to the Main Menu to turn this feature off.

**Note:** The manual mode is for dedicated cameras that are connected to the 12VDC+ ignition wire and are always on while driving, it is not meant for cameras that are connected to the vehicle's reverse light.

## Adjusting Front and Rear Camera Screen Image

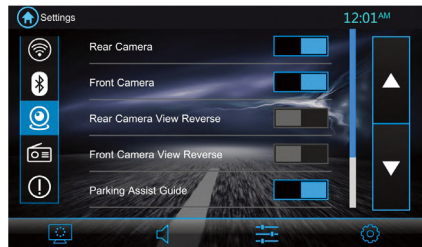

If your front or rear cameras appear to have a reversed image on the radio's display, go into the Camera section in the Settings menu to reverse the image of the camera. To do this, toggle the "Rear Camera View Reverse" or "Front Camera View Reverse" function to correct the viewing angle of the camera(s).

## SWC Input Operation

The built-in SWC Interface is compatible with PAC steering wheel control modules.

The PAC SWI-RC is recommended. A third-party adapter must be used in order for the DCPA723W-M to be compatible with any steering wheel controls. The following controls are available for most vehicles.

1. Preset Up/Down	4. Seek/Track Down (-)	7. Volume Down (-)	10. BT End
2. Mode	5. Mute	8. Band	
3. Seek/Track Up (+)	6. Volume Up (+)	9. BT Talk	

**Note:** Not all OE steering wheel functions may be supported by the DCPA723W-M.

## PAC SWI-RC Installation Hints

1. Set "Radio Select Switch". Set the SWI-RC to position 7 - "Pioneer/Other/Sony".
2. To program, use the Pioneer/Sony/Other radio function mapping order for DUAL units.
3. When programming the SWI-RC, if a function is not supported (or not desired), then the function **MUST** be skipped as per the PAC SWI-RC instructions.
4. The SWC function **MUST** be programmed in the correct order per the PAC SWI-RC radio function mapping order instructions.

Function Order	Function Mapping	SWI-RC (3.3VDC Reference)	
		Center Pin (Ring) Voltage (Function Select)	Tip Pin Voltage
1	Preset Up/Down	L 0.0V	1.54/1.81
2	Mode	H 3.3V	0.6
3	Seek + / Track +	H 3.3v	1.54
4	Seek - / Track -	H 3.3v	1.81
5	Mute	H 3.3v	1.01
6	Volume +	H 3.3v	2.07
7	Volume -	H 3.3v	2.32
8	Band	H 3.3v	2.73
9	BT Talk	L 0.0V	0.60
10	BT End	L 0.0V	1.01

# SiriusXM® Satellite Radio Operation

From the main menu, touch the SXM icon on the main screen.

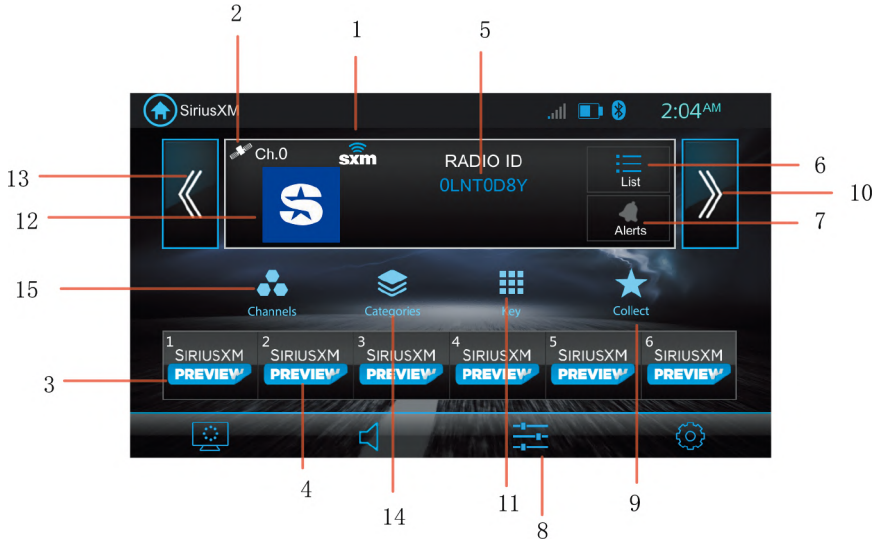

- ① Band Selector
- ② Satellite Strength
- ③ BAND Presets 1~6
- ④ Channel Info
- ⑤ File Information
- ⑥ Additional Options
- ⑦ Favorites Alert
- ⑧ Equalizer
- ⑨ Favorites
- ⑩ Next
- ⑪ Direct Channel Entry
- ⑫ Channel/Album Artwork
- ⑬ Previous
- ⑭ Category
- ⑮ Channel

# SiriusXM® Radio Operation-Part 1

## Channel Manager

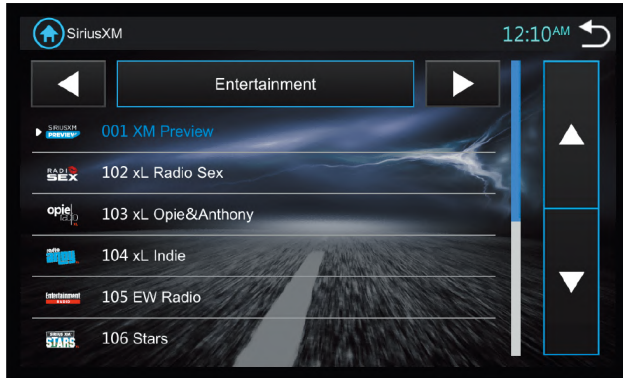

## Category Manager

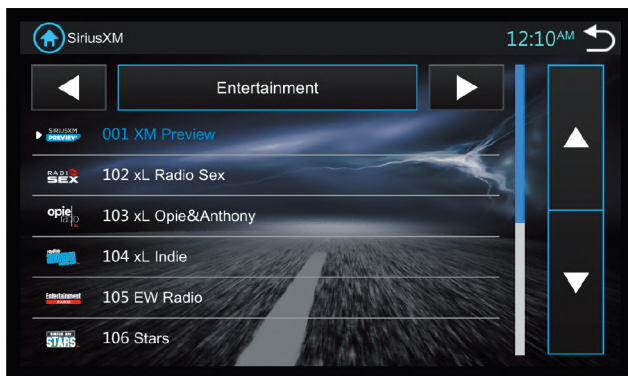

# SiriusXM® Radio Operation-Part 2

## Favorite Selection



Alert is active when a Favorite Song or Artist is available

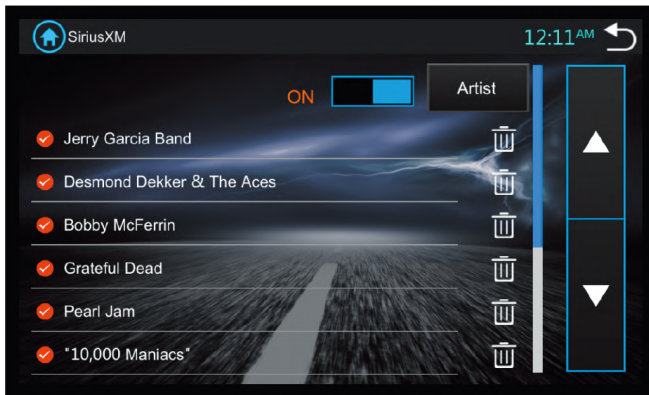

# SiriusXM® Parental Control



## Settings Menu

1. On the SiriusXM menu touch Parental Control. The Enter password Screen appears.
2. Enter your 4-digit password. The following screen appears:

### Lock / Unlock Screen



3. Touch to Station lock, touch lock icon to unlock, the icon will disappear. Channel is unlocked. The Change Password option allows you to change the password from the default or current custom password to another password.



NOTE: The default password is 0 0 0 0.

#### To Change password:

1. Enter into Settings menu. Go to \$XM to change password.
2. Enter your 4-digit password and press the OK icon.
3. Enter the new 4-digit password and press the OK icon. The new password is set.

## SiriusXM® Radio Advisory Messages

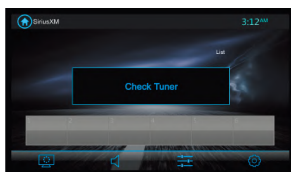

SiriusXM Advisory Message	Recommendation
Check Antenna	<ol style="list-style-type: none"> <li>1.The radio has detected a fault with the SiriusXM antenna. The antenna cable may be either disconnected or damage.</li> <li>2.Verify that the antenna cable is connected to the SiriusXM Connect Vehicle Tuner.</li> <li>3.Inspect the antenna cable for damage and kinks. Replace the antenna if the cable is damaged.</li> <li>4.SiriusXM products are available at your local car audio retailer or online at <a href="http://www.shop.siriusxm.com">www.shop.siriusxm.com</a>.</li> </ol>
Check Tuner	<ol style="list-style-type: none"> <li>1.The radio is having difficulty communicating with the SiriusXM Connect Vehicle Tuner. The tuner may be disconnected or damaged.</li> <li>2.Verify that the SiriusXM Connect Vehicle Tuner cable is securely connected to the radio.</li> </ol>
No Signal	<ol style="list-style-type: none"> <li>1.The SiriusXM Connect Vehicle Tuner is having difficulty receiving the SiriusXM satellite signal.</li> <li>2.Verify that your vehicle is outdoors with a clear view of the sky.</li> <li>3.Verify that the SiriusXM magnetic mount antenna is mounted on a metal surface on the outside of the vehicle.</li> <li>4.Move the SiriusXM antenna away from any obstructions.</li> <li>5.Inspect the antenna cable for damages and kinks.</li> <li>6.Consult the SiriusXM Connect Vehicle tuner installation manual for more information on antenna installation. Replace the antenna if the cable is damaged. SiriusXM products are available at your local car audio retailer or online at <a href="http://www.shop.siriusxm.com">www.shop.siriusxm.com</a>.</li> </ol>
Subscription Updated	<p>This channel is not included in your SiriusXM® subscription plan. In the USA, visit <a href="http://www.siriusxm.com">www.siriusxm.com</a> or call 1-866-635-2349 if you have questions about your subscription. In Canada, visit <a href="http://www.siriusxm.ca">www.siriusxm.ca</a> or call 1-888-539-7474 if you have questions about your subscription.</p>
Channel Unavailable	<p>The channel that you have requested is not a valid SiriusXM channel or the channel that you were listening to is no longer available. You may also see this message briefly when first connecting a new SiriusXM Connect Vehicle tuner. Visit <a href="http://www.siriusxm.com">www.siriusxm.com</a> for more information about the SiriusXM channel lineup.</p>
Channel Unsubscribed	<p>The channel that you have requested is not included in your SiriusXM subscription package or is no longer included in your SiriusXM subscription package. In the USA, visit <a href="http://www.siriusxm.com">www.siriusxm.com</a> or call 1-866-635-2349 if you have questions about your subscription. In Canada, visit <a href="http://www.siriusxm.ca">www.siriusxm.ca</a> or call 1-888-539-7474 if you have questions about your subscription.</p>



---

<p>Channel Locked</p>	<p>The channel that you have requested is locked by the radio's Parental Control feature. Refer to the SiriusXM® Satellite Radio Operation section for more information on the Mature Channel Lock feature and how to access.</p>
-----------------------	---



## iDatalink Operation

### Summary

You can access the satellite radio source provided for the vehicle. The vehicle information and many OEM systems such as steering wheel controls, warning chimes, driver safety systems, and etc. can be displayed on this product by connecting the optional iDatalink adaptor. It is also possible to add visual screens such as gauges, vehicle information, climate control, and parking assist. However, an extra interface module is required to access these features.

### NOTE

Since the type of module varies depending on the vehicle model, search for your vehicle via the following URL to determine which features are available for each module. Remember to select the correct radio model for accurate results.

<https://www.idatalinkmaestro.com/en>

### Important

- For details about vehicle models that are compatible with the iDatalink adaptor, refer to the information on our website.
- After installing the iDatalink adaptor, be sure to check that it operates properly.
- Functions and displays vary depending on the vehicle model. For details on the functions available for each model, refer to the information on our website.
- For troubleshooting information about iDatalink functions, visit the following website:  
<https://www.idatalinkmaestro.com/en/support/faq>

### Limitations

- The data is transmitted to this product from your vehicle system via the connected iDatalink adaptor.
- Therefore, the actual data contents displayed on your product may differ from the contents on the screen described in this manual.
- When information on your vehicle or on the devices in your vehicle is sent from the iDatalink Maestro module, a screen notifying you of such information may pop up.

### TIP

The operating buttons, text information, etc. overlaid on the camera view screen may not appear immediately after turning on the ignition switch.

## iDatalink Operation

### Activating iDatalink Maestro

Before using and/or connecting the iDatalink Maestro adaptor, you will need to first flash the Maestro RR module with the appropriate vehicle and head unit firmware.

1. Find the Maestro serial number of this product. Ensure you have the entire serial number (all 16 Arabic numerals) available.

**Note:** Entering only the last 7 digits may cause the flashing process to fail or cause communication issues with the head unit.

2. Access the following website and follow the on-screen instructions to configure the desired firmware.  
<https://www.idatalinkmaestro.com/en>

### NOTE

When the serial number input is required, input the device number of this product.

3. Install the vehicle/head unit-specific firmware on your iDatalink Maestro module.

4. Connect this product to the iDatalink Maestro and install this product to the vehicle. The iDatalink function will be active.

### NOTES

- For details on installing the firmware, refer to iDatalink Maestro website.
- For details on connecting this product to iDatalink Maestro, refer to the Installation Manual.
- You can also check the device number (serial number) on the [Setting > About > Idata SN] screen of this product.

### Starting procedure

1. Connect the iDatalink Maestro adaptor to this product.  
For details, refer to the Installation Manual.





2. Touch  on home screen.

### NOTE

The iDatalink function is available only when the input signal is received by the iDatalink Maestro adaptor.

## iDataLink Operation

You can check and use the following screens after selecting [Car Features] in the starting procedure. Touch one of the icons on the bottom of the screen to switch a feature.

	Displays the Gauges screen.
	Displays the Vehicle Information screen.
	Displays the Climate screen.
	Displays the Parking Assist screen

### Gauges screen



### Vehicle Information screen

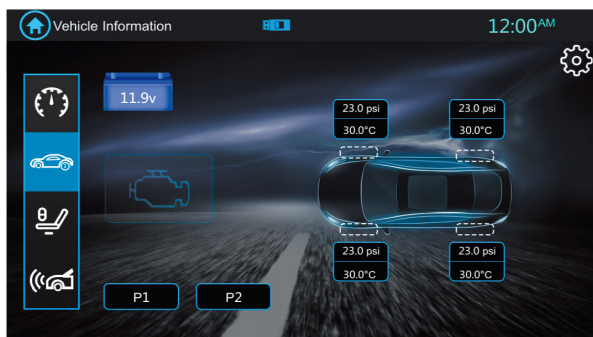

## iDataLink Operation

### Climate screen



### Parking Assist screen



### Displaying obstacle detection information

#### CAUTION

This function is intended solely to assist the driver's vision. It does not detect all dangers and obstacles and is not a substitute for your attentiveness, judgement, and care while parking your vehicle.

#### NOTE

This function is only available for vehicles equipped with a parking sensor system.



## iDatalink Operation

### iDatalink settings

1. Touch Upper right corner  icon

Gauges screen, Vehicle Information screen, Climate screen, Parking Assist screen.

The upper right corner of all four interfaces should have a setting button, which can be clicked to perform corresponding display or function settings.

## Metra Operation

This Dual receiver connects with a compatible Metra programmable interface (optional, purchased separately\*), allowing the unit to display OEM features and functions such as Vehicle Info, Gauge, Vehicle Information, Climate, Parking Assist, Customizations. The functions that are displayed are dependent on what is available on your specific vehicle.

### Parking Assist



### Gauge



# Metra Operation

## Vehicle Information

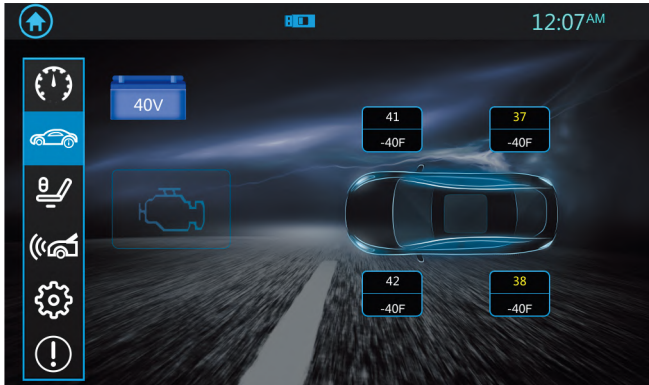

## Climate



# Metra Operation

## Customizations

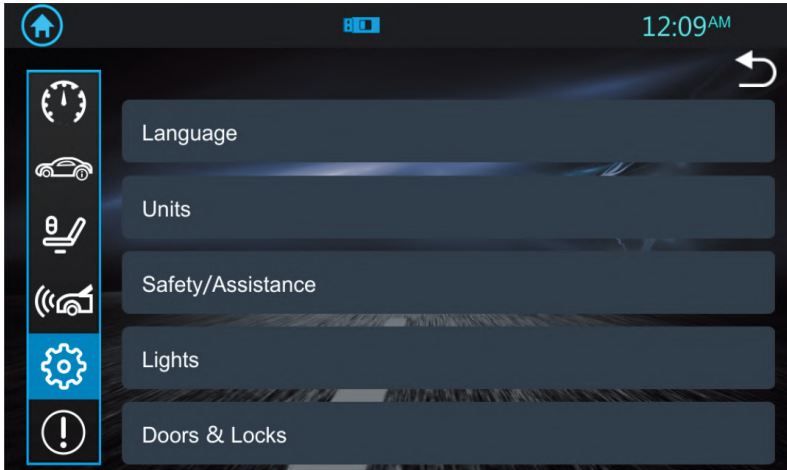



## Troubleshooting

General		
Problem	Cause	Action
Unit will not turn on (no power)	Yellow wire not connected or incorrect voltage. Red wire not connected or incorrect voltage	Check connections for proper voltage ( 11- 16VDC)
	Black wire not connected	Check connection to ground
	Fuse blown	Replace fuse(s)
Unit has power (but no sound)	Speaker wires not connected	Check connections at speakers
	One or more speaker wires touching each other or touching chassis ground	Insulate all bare speaker wires from each other and chassis ground
Unit blows fuse(s)	Yellow or red wire touching chassis ground	Check for pinched wire
	Speaker wires touching chassis ground	Check for pinched wire
	Incorrect fuse rating	Use fuses with correct rating
Unit has audio (but no video)	Parking brake safety circuit not connected Parking brake not applied	Check connections at parking brake Apply parking brake as described in manual
IR remote does not work	Dead battery	Replace battery

### For Your Records

Please keep your original sales receipt and be prepared to provide this receipt in the event you require service, as your original receipt is considered the best proof of purchase and indicates the date you purchased your Dual product.

Dealer Name \_\_\_\_\_  
Dealer Phone \_\_\_\_\_  
Purchase Date \_\_\_\_\_

### Register Your Product

Register your product online at [www.dualav.com](http://www.dualav.com).

## Specifications

<b>FM Tuner</b>	<p>Tuning range: <b>87.5MHz-107.9MHz</b>          Usable sensitivity: <b>10dBf</b>          50dB quieting sensitivity: <b>20dBf</b>          Stereo separation @ 1kHz: <b>38dB</b>          Frequency response: <b>30Hz-13kHz</b></p>
<b>AM Tuner</b>	<p>Tuning range: <b>530kHz-1710kHz</b>          Usable sensitivity: <b>24uV</b>          Frequency response: <b>30Hz-2.3kHz</b></p>
<b>Rear USB</b>	<p>Compatibility: <b>High Speed USB 2.0</b>          USB Class: <b>Mass storage class (There are two USB ports: 1. USB-C: for Charging and Playback; 2. USB-A: only for AA/ CP with charging but no playback)</b></p>
<b>Monitor</b>	<p>Panel size: <b>7" diagonal measurement</b>          View angle (up/down/left/right): <b>50/70/70/70</b>          Resolution: <b>1024(H) x 600(V)</b>          Brightness (cd/m2): <b>500</b>          Contrast ratio: <b>500:1</b>          Pixels: <b>1,843,200</b></p>
<b>General</b>	<p>Speaker output impedance: <b>4 ohms</b>          Line output voltage: <b>4 volt RMS</b>          Line output impedance: <b>200 ohms</b>          Chassis dimensions: <b>7" X 3.8" X 4" (W x D x H)</b></p> <p>Design and specifications subject to change without notice.</p>



CEA-2006 Power Standard Specifications  
 (reference: 14.4VDC +/- 0.2V, 20Hz~20kHz)

Power Output: 14 Watts RMS x 4 channels at 4 ohms  
 and ≤1% THD+N  
 Signal to Noise Ratio: 75 dBA (reference: 1 watt into 4 ohms)



## Limited One Year\* Warranty

This warranty gives you specific legal rights. You may also have other rights which vary from state to state.

Dual Electronics Corp. warrants this product to the original purchaser to be free from defects in material and workmanship for a period of one year from the date of the original purchase.

Dual Electronics Corp. agrees, at our option, during the warranty period, to repair any defect in material or workmanship or to furnish an equal new, renewed or comparable product (whichever is deemed necessary) in exchange without charges, subject to verification of the defect or malfunction and proof of the date of purchase. Subsequent replacement products are warranted for the balance of the original warranty period.

**Who is covered?** This warranty is extended to the original retail purchaser for products purchased from an authorized DUAL dealer and used in the U.S.A.

**What is covered?** This warranty covers all defects in material and workmanship in this product. The following are not covered: software, installation/removal costs, damage resulting from accident, misuse, abuse, neglect, product modification, improper installation, incorrect line voltage, unauthorized repair or failure to follow instructions supplied with the product, or damage occurring during return shipment of the product. Specific license conditions and copyright notices for the software can be found via [www.dualav.com](http://www.dualav.com).

### Warranty Coverage

\*Limited 1-year warranty. (Proof of purchase required)

- Extended Coverage: Extend your warranty from 1 year to 2 years when you register online at [www.dualav.com](http://www.dualav.com). Registration must be completed within 60 days of the original purchase date to qualify for this extension.

### What to do?

1. Before you call for service, check the troubleshooting guide in your owner's manual. A slight adjustment of any custom controls may save you a service call.
2. If you require service during the warranty period, you must carefully pack the product (preferably in the original package) and ship it by prepaid transportation with a copy of the original receipt from the retailer to an authorized service center.
3. Please describe your problem in writing and include your name, a return UPS shipping address (P.O. Box not acceptable), and a daytime phone number with your shipment.
4. For more information and for the location of the nearest authorized service center please contact us by one of the following methods:
  - Call us toll-free at 1-866-382-5476 (Monday-Friday, 9:00 am, to 5:00 pm, EST)
  - E-mail us at [cs@dualav.com](mailto:cs@dualav.com)

**Exclusion of Certain Damages:** This warranty is exclusive and in lieu of any and all other warranties, expressed or implied, including without limitation the implied warranties of merchantability and fitness for a particular purpose and any obligation, liability, right, claim or remedy in contract or tort, whether or not arising from the company's negligence,



Dual Electronics Corp.  
Toll Free:1-866-382-5476  
Monday-Friday, 9AM-5PM EST  
[www.dualav.com](http://www.dualav.com)  
©2026 Dual Electronics Corp. All rights reserved.

NSC0426-V01